

KENWOOD

AUDIO VIDEO SURROUND RECEIVER

KR-V999D

INSTRUCTION MANUAL

KENWOOD CORPORATION

Preparations

Operations

Remote Control

Other

About the supplied remote control . . .

Compared to standard remote controls, the remote control supplied with this receiver has several operation modes. These modes enable the remote control to perform on screen operations and control other audio/video components. In order to effectively use the remote control it is important to read the operating instructions and obtain a proper understanding of the remote control and how to switch its operation modes (etc.).

Using the remote control without completely understanding its design and how to switch the operation modes may result in incorrect operations.

Before applying the power

Units are designed for operation as follows.

U.K. and Europe AC 230 V only

For the United Kingdom

Factory fitted moulded mains plug

1. The mains plug contains a fuse. For replacement, use only a 13-Amp ASTA-approved (BS1362) fuse.
2. The fuse cover must be refitted when replacing the fuse in the moulded plug.
3. Do not cut off the mains plug from this equipment. If the plug fitted is not suitable for the power points in your home or the cable is too short to reach a power point, then obtain an appropriate safety approved extension lead or adapter, or consult your dealer. If nonetheless the mains plug is cut off, remove the fuse and dispose of the plug immediately, to avoid a possible shock hazard by inadvertent connection to the mains supply.

IMPORTANT

The wires in the mains lead are coloured in accordance with the following code: **Blue : Neutral**

Brown : Live

Do not connect those leads to the earth terminal of a three-pin plug.



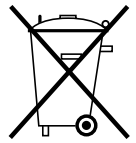

REQUIREMENT BY NEDERLAND GAZETTE

Batteries are supplied with this product. When they empty, you should not throw away. Instead, hand them in as small chemical waste.



Safety precautions

WARNING : TO PREVENT FIRE OR ELECTRIC SHOCK, DO NOT EXPOSE THIS APPLIANCE TO RAIN OR MOISTURE.

	CAUTION RISK OF ELECTRIC SHOCK DO NOT OPEN		CAUTION: TO REDUCE THE RISK OF ELECTRIC SHOCK, DO NOT REMOVE COVER (OR BACK). NO USER-SERVICEABLE PARTS INSIDE, REFER SERVICING TO QUALIFIED SERVICE PERSONNEL.
	THE LIGHTNING FLASH WITH ARROWHEAD SYMBOL, WITHIN AN EQUILATERAL TRIANGLE, IS INTENDED TO ALERT THE USER TO THE PRESENCE OF UNINSULATED "DANGEROUS VOLTAGE" WITHIN THE PRODUCT'S ENCLOSURE THAT MAY BE OF SUFFICIENT MAGNITUDE TO CONSTITUTE A RISK OF ELECTRIC SHOCK TO PERSONS.		
	THE EXCLAMATION POINT WITHIN AN EQUILATERAL TRIANGLE IS INTENDED TO ALERT THE USER TO THE PRESENCE OF IMPORTANT OPERATING AND MAINTENANCE (SERVICING) INSTRUCTIONS IN THE LITERATURE ACCOMPANYING THE APPLIANCE.		

Unpacking

Unpack the unit carefully and make sure that all accessories are put aside so they will not be lost.

Examine the unit for any possibility of shipping damage. If your unit is damaged or fails to operate, notify your dealer immediately. If your unit was shipped to you directly, notify the shipping company without delay. Only the consignee (the person or company receiving the unit) can file a claim against the carrier for shipping damage.

We recommend that you retain the original carton and packing materials for use should you transport or ship the unit in the future.

Accessories

FM indoor antenna (1)

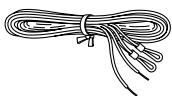

Antenna adaptor (1)

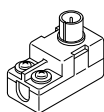

AM loop antenna (1)

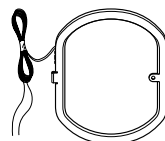

Loop antenna stand (1)

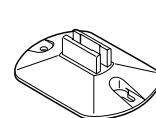

Remote control unit (1)

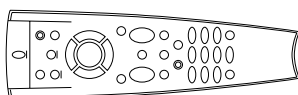

Batteries (R03/AAA) (4)

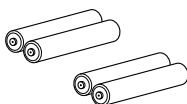

RF DEMODULATOR (1)





AC adaptor (1)
Power cord (1)
RCA pin cord (2)

Contents

Caution : Read the pages marked  carefully to ensure safe operation.

3

Preparations	Getting started	2
	 Before applying the power	2
	 Safety precautions	2
	Unpacking	2
	Special features	4
	How to use this manual	5
	Names and functions of parts	6
	Setting up the system	8
	Connecting the antennas	8
	Connecting audio components	9
	Connecting video components	10
Digital connections	11	
Connecting the system control	12	
Connecting the speakers	13	
Making connections to another room (ROOM B)	15	
Preparing the remote control	16	
Preparing for surround sound	17	
Using the on-screen display	17	
Surround setup	18	
Operations	Normal playback	20
	Listening to a source component	20
	Adjusting the sound	21
	Recording	23
	Recording audio	23
	Recording video	24
	Listening to radio broadcasts	25
	Tuning (non-RDS) radio stations	25
	Tuning radio stations by frequency (DIRECT tuning)	26
	Using RDS (Radio Data System)	27
	Using the DISPLAY key	27
	Presetting RDS stations (RDS AUTO MEMORY)	28
	Receiving preset RDS stations	28
	Presetting radio stations manually	29
	Receiving preset stations	29
	Receiving preset stations in order (P.CALL)	29
	Tuning by program type (PTY search)	30
Reserving the desired information	32	
Ambience effects	34	
Sound modes	34	
Surround play	36	
Remote Control	Getting the most from your remote control	40
	Registering setup codes for other components	40
	Operating other components	42
	Changing (confirming) the operation mode	43
	Preparing for automatic operations (MACRO play)	44
	Executing an automatic operation	46
	Controlling the sound in another room (ROOM B)	47
	Setup code correlation	48
FutureSet upgrade option	49	
Other	Set up code chart	51
	In case of difficulty	57
	 Specifications	59
	Remote operation of other components	60

True home theater sound

This receiver incorporates a wide variety of surround modes to bring you maximum enjoyment from your video software. Select a surround mode according to your equipment or the software you are going to play and enjoy! → 34

Dolby Digital (AC-3)

The DOLBY DIGITAL (AC-3) mode lets you enjoy full digital surround from software processed in the Dolby Digital (AC-3) format. Dolby Digital (AC-3) provides up to 5.1 channels of independent digital audio for better sound quality and more powerful presence than conventional Dolby Surround.

Dolby Pro Logic & Dolby 3 Stereo

This surround system reproduces theater-like surround sound from video software marked  **DOLBY SURROUND**.

The PRO LOGIC mode uses the built-in directivity enhancer circuit to control the Left, Center, Right and Surround channel audio signals and reproduce a real sense of sound motion.

The 3 STEREO mode uses the directivity enhancer circuit to provide proper acoustic positioning and a real sense of sound motion even when only the front and center speakers are used.

New DSP surround modes

The DSP (Digital Signal Processor) used for this receiver incorporates a variety of high quality adjustable sound fields, like "ARENA", "JAZZ CLUB", "STADIUM", "CHURCH" and "THEATER", to add the "presence" associated with an arena, jazz club or stadium (etc.) to the original signal. It is compatible with almost any kind of program source.

Universal IR (InfraRed) remote control

In addition to the basic receiver and OSD operations, the remote control supplied with this receiver can also operate almost all of your remote controllable audio and video components. Just follow the simple setup procedure to register the components you have connected. → 40

Dual IR emitters

This remote control has two IR emitters: one to send commands in a straight line over long distances, allowing you to control the receiver and your other components from farther away; and one for wide dispersion of commands in a closer proximity, for near-field operation even when the remote control is not pointed directly at the respective component. → 16

MACRO play

The MACRO function lets you perform a series of operations automatically, like turning ON the power of the receiver and connected components, switching the input selectors, and starting playback. (Be sure to register your components before starting the macro set up procedure.) → 44

FutureSet, automatic update feature

This function lets you update the remote control so it can operate new components which do not appear in the setup code list at the end of the manual. Therefore, the remote control will always be compatible. → 49

Easy surround setup and operation with OSD (On Screen Display)

This function takes advantage of your monitor TV to simplify the surround setup procedures so you can quickly and easily match the surround processing to your speaker system, and your listening environment.

You can also use OSD during playback to customize the DSP surround modes, etc. → 17

RDS (Radio Data System) tuner

The receiver is equipped with a RDS tuner that provides several convenient tuning functions: RDS Auto Memory, to automatically preset up to 40 RDS stations broadcasting different programs; station name display, to show you the name of the current broadcast station; and PTY search to let you tune stations by program type. → [27](#)

On screen Radio Text

Although most RDS compatible tuners and receiver's can display the name of the current broadcast station, this receiver goes one step further by allowing you to display the station name, as well as any other text messages broadcast from the current station, in large easy to read characters on the screen of your monitor TV. You can even display radio text from an RDS station while enjoying a different source component! → [27](#)

PTY (Program TYpe) search

Lets you tune stations by specifying the type of program you want to hear. → [30](#)

EON (Enhanced Other Networks) reservation

The EON function lets you monitor information on other stations so you can receive traffic, news, or information programs as soon as they are broadcast, even they are broadcast on a station different from the one you are currently listening to. When the broadcast ends, the receiver returns to the original station. When listening to KENWOOD source components connected with system control cords, the input selector on the receiver automatically switches to the tuner when a program you desire is broadcast. → [32](#)

Dual room installation capability

In addition to the standard "A" speaker output terminals for use in your main system, this receiver also incorporates separate "B" speaker terminals and "Room B" RCA video and stereo output jacks. This system lets you use the remote control to control and output audio and video to "Room B" independent of "Room A." → [15](#) → [47](#)

New TRAITR transistor adopted in the final stage

A new TRAITR transistor which features superior temperature tracking characteristics has been adopted in the final stage of the power amplifier block. This new TRAITR transistor combines a temperature compensation resistor with an emitter resistor and final transistor to provide ideal temperature compensation characteristics and minimize distortion caused by temperature variations.

How to use this manual

This manual is divided in to four sections, Preparations, Operations, Remote Control, and Other.

Preparations

Shows you how to connect your audio and video components to the receiver and prepare the surround processor. We've tried to make setting up your system as easy as possible. However, since this receiver works with all of your audio and video components, connecting the system can be fairly complex.

Operations

Shows you how to operate the various functions available from the receiver.

Remote Control

Shows you how to operate the various functions available from the remote control. We've designed this remote control to integrate your entire audio/video system and let you operate all of your entertainment components — your TV, VCR, LD player, CD player, etc. Remember that before you can use the remote control to operate these components, they must be registered with a proper setup code.

Other

Includes additional information such as; a list of setup codes for registering your other components, a troubleshooting guide, specifications, and a reference guide to the remote operations available for registered components.

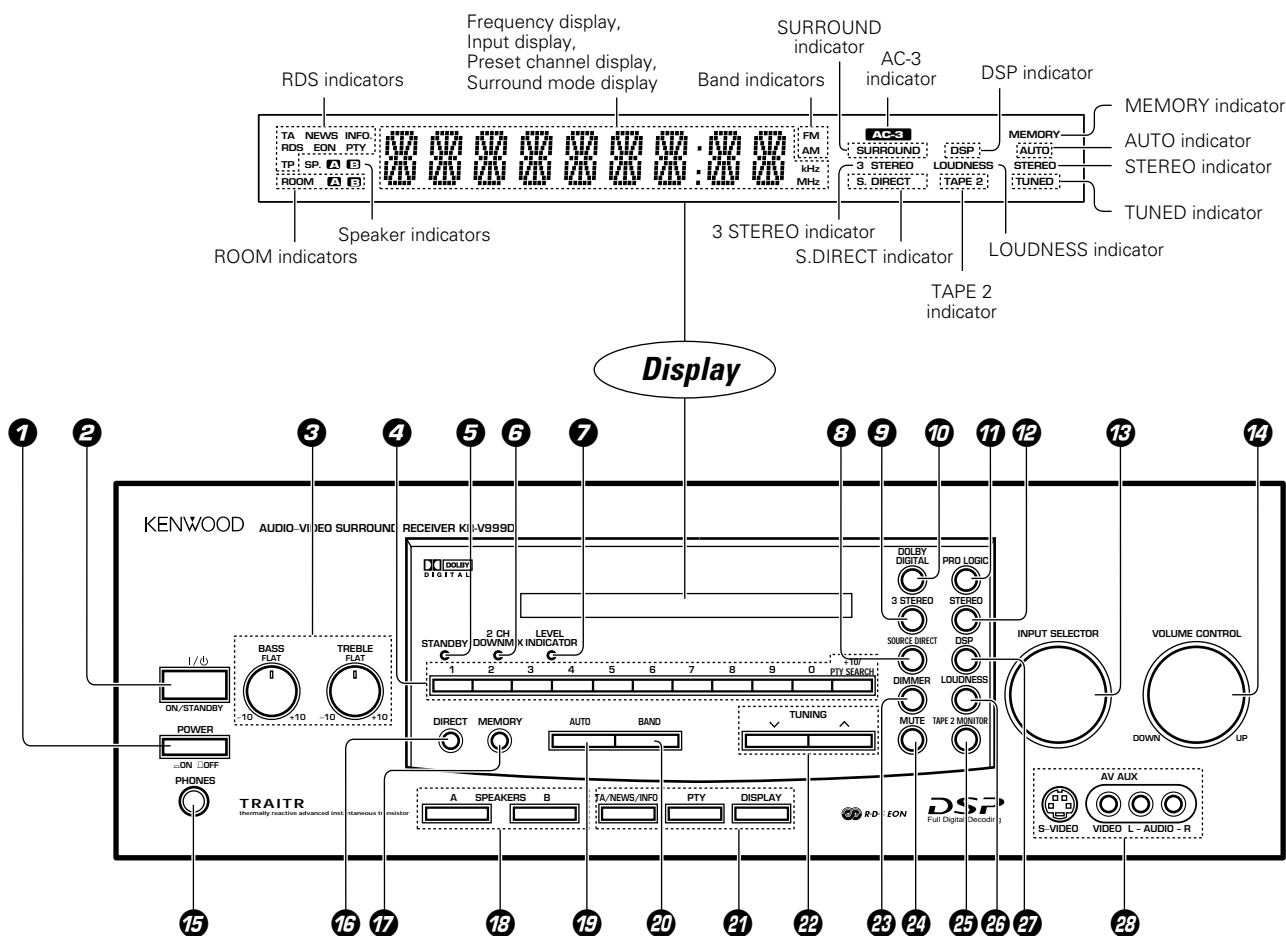

- | | | |
|--|--|---|
| <p>1 POWER key → 20
Use to turn the main power ON/OFF.</p> <p>2 ON/STANDBY (I/O) key → 20
Use to switch the power ON/STANDBY when the POWER is turned ON.</p> <p>3 Tone Control knobs → 21</p> <p>4 Numeric keys</p> <p>5 STANDBY indicator</p> <p>6 2 CH DOWNMIX indicator
Lights when an DOLBY DIGITAL (AC-3) format signal is being downmixed to 2 channel stereo.</p> <p>7 LEVEL indicator → 19
Lights when the level of the signal being input is too high.</p> <p>8 SOURCE DIRECT key → 22</p> <p>9 DOLBY 3 STEREO key → 34
Use to turn on the DOLBY 3 STEREO mode.</p> | <p>10 DOLBY DIGITAL key → 34
Use to turn on the DOLBY DIGITAL (AC-3) mode.</p> <p>11 PRO LOGIC key → 34
Use to turn on the DOLBY PRO LOGIC mode.</p> <p>12 STEREO key
Use to cancel the surround mode.</p> <p>13 INPUT SELECTOR knob → 20
Use to select the input sources.</p> <p>14 VOLUME CONTROL knob → 20</p> <p>15 PHONES jack → 22
Use for headphone listening.</p> <p>16 DIRECT key → 26
Use to tune radio stations directly by numerical input.</p> <p>17 MEMORY key → 28 - 29
Use to store radio stations in the preset memory.</p> <p>18 SPEAKERS A/B keys → 20 - 47
Use to turn the speakers ON/OFF.</p> | <p>19 AUTO key ∞
Use to select the auto tuning mode.</p> <p>20 BAND key ∞
Use to select the broadcast band.</p> <p>21 RDS keys → 27 - 30 - 32</p> <p>22 TUNING keys ∞
Use to tune in radio broadcasts.</p> <p>23 DIMMER key
Use to adjust the brightness of the display.</p> <p>24 MUTE key → 21
Use to mute the sound.</p> <p>∞ TAPE 2 MONITOR key → 23
Use to monitor a recording.</p> <p>25 LOUDNESS key → 21
Use to activate the frequency weighting network.</p> <p>27 DSP key → 35
Use to turn on, or switch, the DSP mode.</p> <p>28 AV AUX jacks → 10</p> |
|--|--|---|

About the STANDBY indicator

This unit has a **STANDBY** indicator. When the **STANDBY** indicator is lit, the unit consumes a small amount of power to preserve the memory. This is called STANDBY mode. This mode also lets you turn the power ON using the remote control.

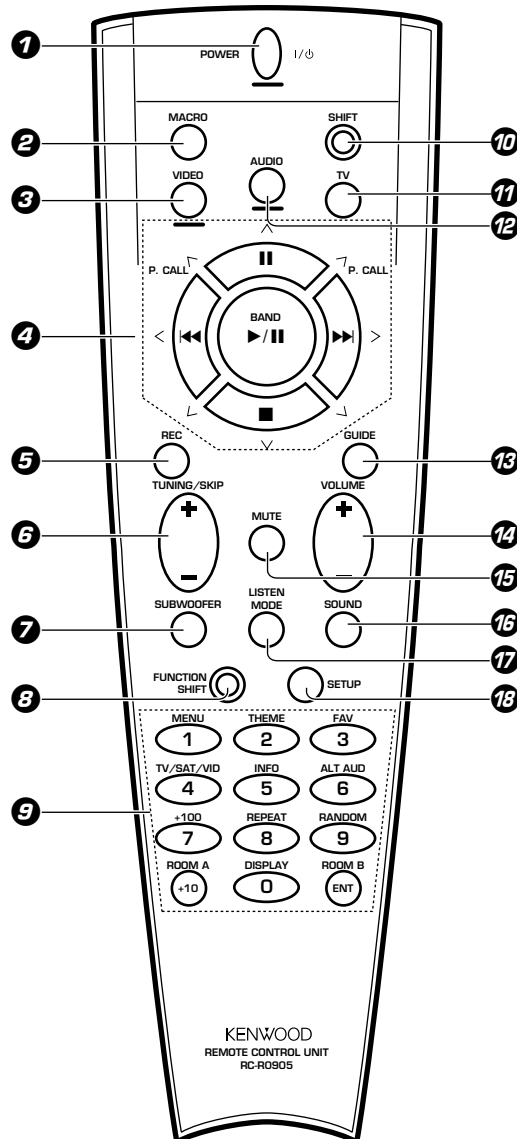

1 POWER key

- 42

Use to turn the receiver on and off.
Use in combination with the input selector (AUDIO, VIDEO, or TV) keys and SHIFT key to turn various components on and off.

2 MACRO key

- 44

Use in combination with the AUDIO, VIDEO, or TV keys to execute a series of commands automatically (MACRO PLAY).

3 VIDEO selector key

- 40

Selects the video inputs (VIDEO 1, VIDEO 2, VIDEO 3, VIDEO 4, AV AUX) and sets the remote to operate the component registered at the respective input.

4 Multi control keys

- 60

Use to operate the selected component and to operate the on-screen display.

5 REC key

- 60

Use to operate the selected component.

6 TUNING/SKIP key

- 18 - 60

Use during the setup procedure to specify various settings. Use to operate the tuner or selected component.

7 SUBWOOFER key

°

Use in combination with the VOLUME +/- keys to adjust the volume of the subwoofer.

8 FUNCTION SHIFT key

- 60

Use in combination with the numeric keys to execute alternate commands.

9 Numeric keys

- 60

Provide functions identical to those of the original remote supplied with the component you are controlling.

To access the functions printed above the keys, Press within 3 seconds of pressing the FUNCTION SHIFT key. Function availability varies for each component.

10 SHIFT key

- 43

Use in combination with the AUDIO and VIDEO keys to change the remote control mode without changing the input selector or in combination with the POWER key to turn on and off components programmed into the remote.

11 TV selector key

- 40

Sets the remote to operate a TV or cable box (TV 1, TV 2, CABLE). This key does not change the input selector on the receiver.

12 AUDIO selector key

- 40

Selects the audio inputs (CD, TAPE1/MD, TUNER, PHONO) and sets the remote to operate the respective KENWOOD audio component.

If you connect audio components from KENWOOD and other makers to the TAPE1/MD or CD jacks, you can set the remote to operate these components by registering the appropriate setup code at the respective input.

13 GUIDE key

- 60

Use to activate the OSD menu functions of registered components.

14 VOLUME key

- 20

Use to adjust the receiver volume.

15 MUTE key

- 21

Use to temporarily mute the sound.

16 SOUND key

- 36

Use to activate the Sound OSD and set the remote to OSD control mode.

17 LISTEN MODE key

°

Use to select the desired surround mode.

18 SETUP key

- 18

Use to activate the Setup OSD and set the remote to OSD control mode.

Connecting the antennas

Make connections as shown below.

Do not connect the power cord to a wall outlet until all connections are completed.

Antenna terminal connections

- ❶ Push lever.
- ❷ Insert cord.
- ❸ Return lever.

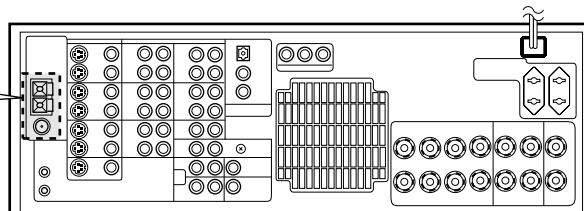
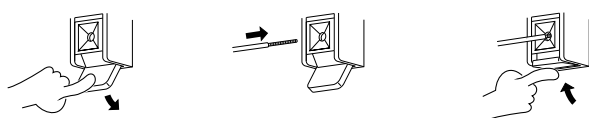

AM loop antenna

The supplied loop antenna is for use indoors. Place it as far as possible from the receiver, TV set, speaker cords and power cord, and adjust the direction for best reception.

FM indoor antenna

The supplied indoor antenna is for temporary use only. For stable signal reception we recommend using an outdoor antenna. Disconnect the indoor antenna when you connect one outdoors.

FM outdoor antenna

Lead the 75Ω coaxial cable connected to the FM outdoor antenna into the room and connect it to the FM 75Ω terminal.

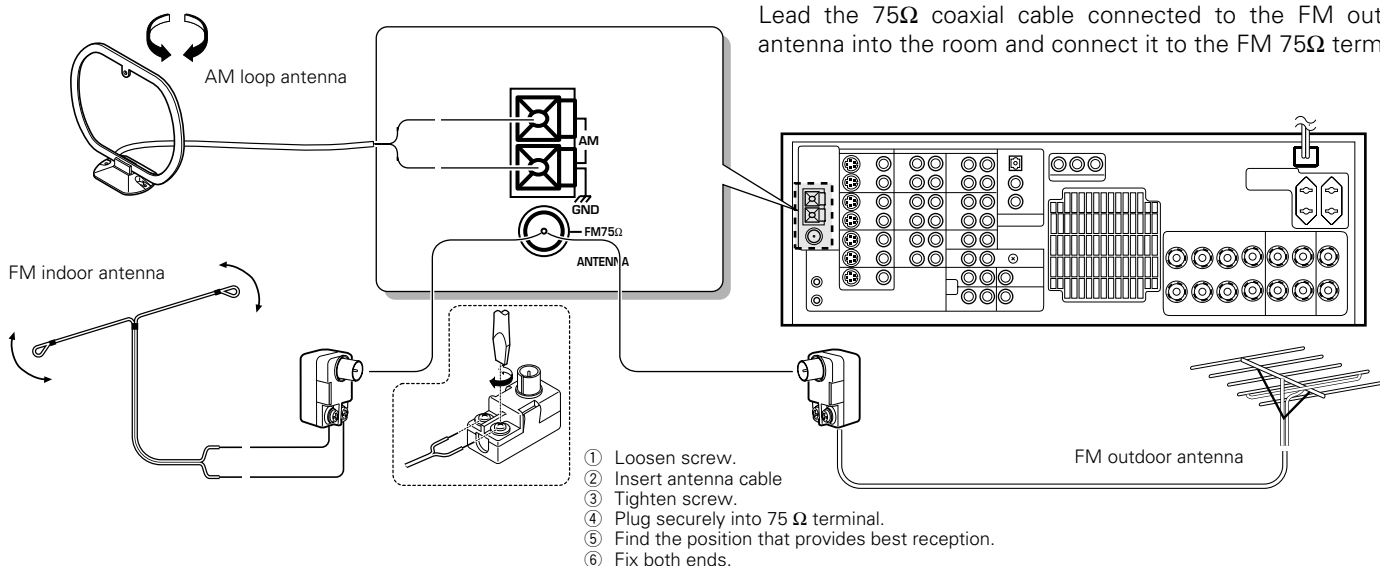

75Ω coaxial cable connection

- ❶ Arrange the coaxial cable as illustrated.

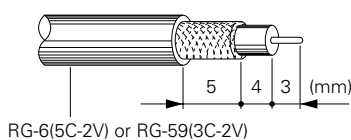

- ❷ Open the antenna adaptor. Open the claws with the fingers to release the lock and pull out the cover.

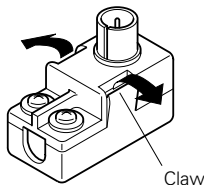

- ❸ Remove the inner conductor from the groove of pole A and insert it in the groove of pole B.

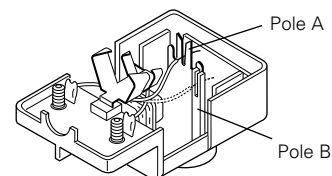

- ❹ Insert into the slit on the clip. Fasten the bands A and B, using a pair of pliers.

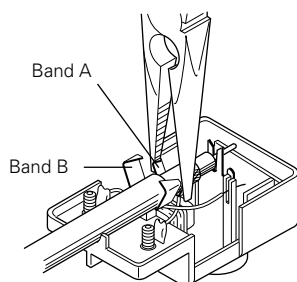

- ❺ Close the cover and connect the adaptor to the antenna terminal.

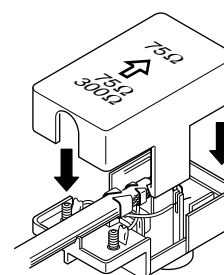

Connecting audio components

Make connections as shown below.

When connecting the related system components, be sure to also refer to the instruction manuals supplied with the components you are connecting.

Do not connect the power cord to a wall outlet until all connections are completed.

Microcomputer malfunction
 If operation is not possible or an erroneous display appears, even though all connections have been made properly, reset the microcomputer referring to "In case of difficulty". → 57

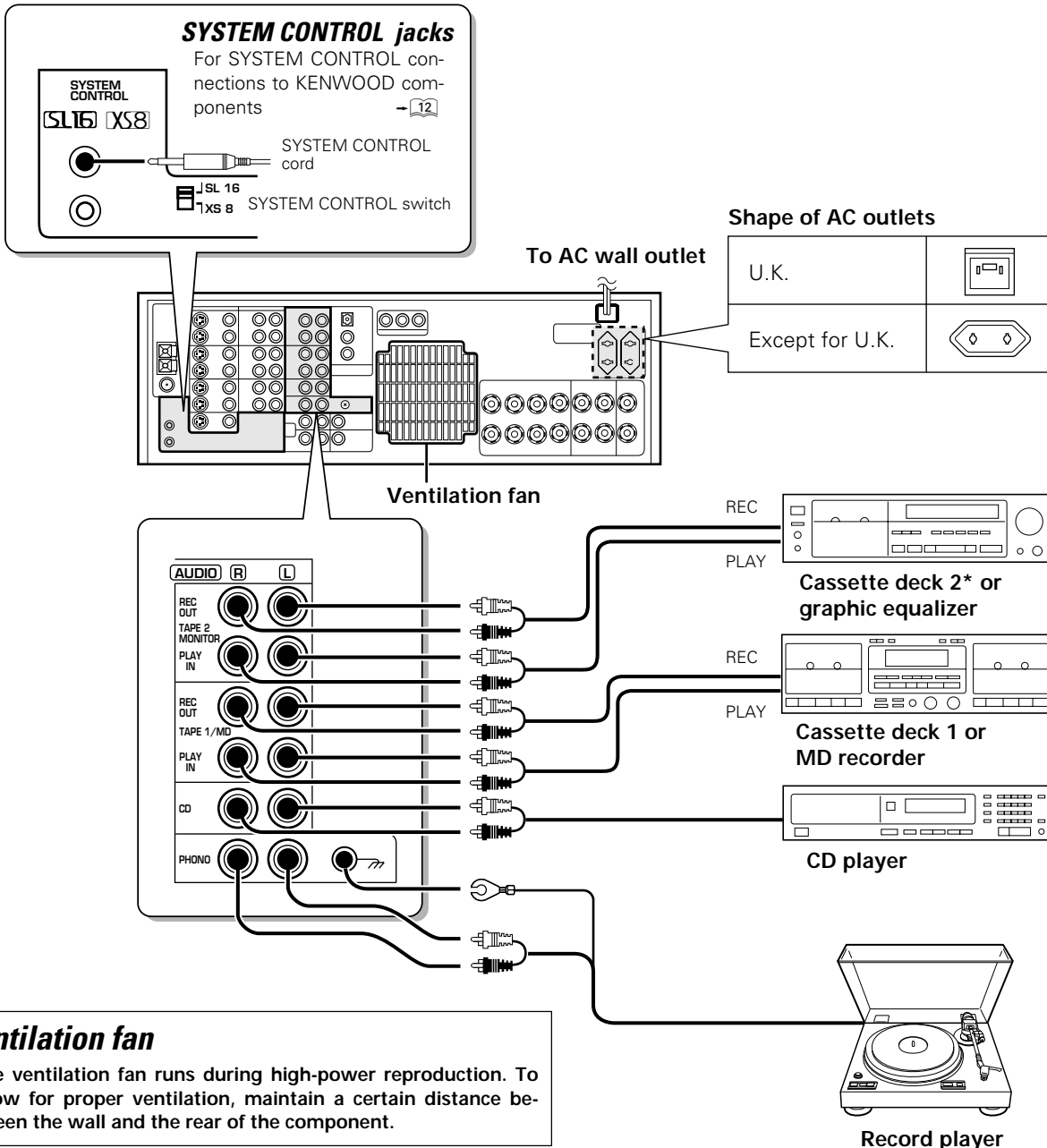

Ventilation fan
 The ventilation fan runs during high-power reproduction. To allow for proper ventilation, maintain a certain distance between the wall and the rear of the component.

Caution regarding placement
 To maintain proper ventilation, be sure to leave a space around the unit (from the largest outer dimensions, including projections) equal to, or greater than shown below:
 Left and right panels: 10 cm, Rear panel: 10 cm, Top panel: 50 cm

* Do not connect a System Control cord to a cassette deck connected to the TAPE 2 MONITOR jacks.

- Notes
1. Connect all cords firmly. Loose connections may prevent proper sound transmission or produce noise.
 2. Be sure to remove the power cord from the AC outlet before plugging or unplugging any connection cords. Plugging / unplugging connection cords without disconnecting the power cord can cause malfunctions and may damage the unit.
 3. Do not connect power cords from components whose power consumption is larger than what is indicated on the AC outlet at the rear of this unit.

Connecting video components

Make connections as shown below.

When connecting the related system components, be sure to also refer to the instruction manuals supplied with the components you are connecting.

Do not connect the power cord to a wall outlet until all connections are completed.

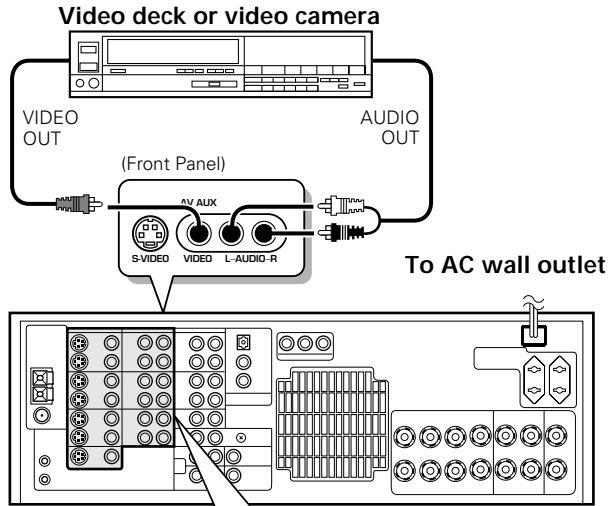

About the S-VIDEO jacks

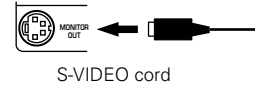

Use the S-VIDEO jacks to make connections to video components with S-VIDEO IN/OUT jacks.

- If you use the S-VIDEO jacks to connect your video playback components, be sure to use the S-VIDEO jacks when connecting your monitor and video recording components.
- When both S-VIDEO and normal video plugs are connected to the MONITOR OUT jacks, the receiver's on screen display is output from the S-VIDEO jack only.

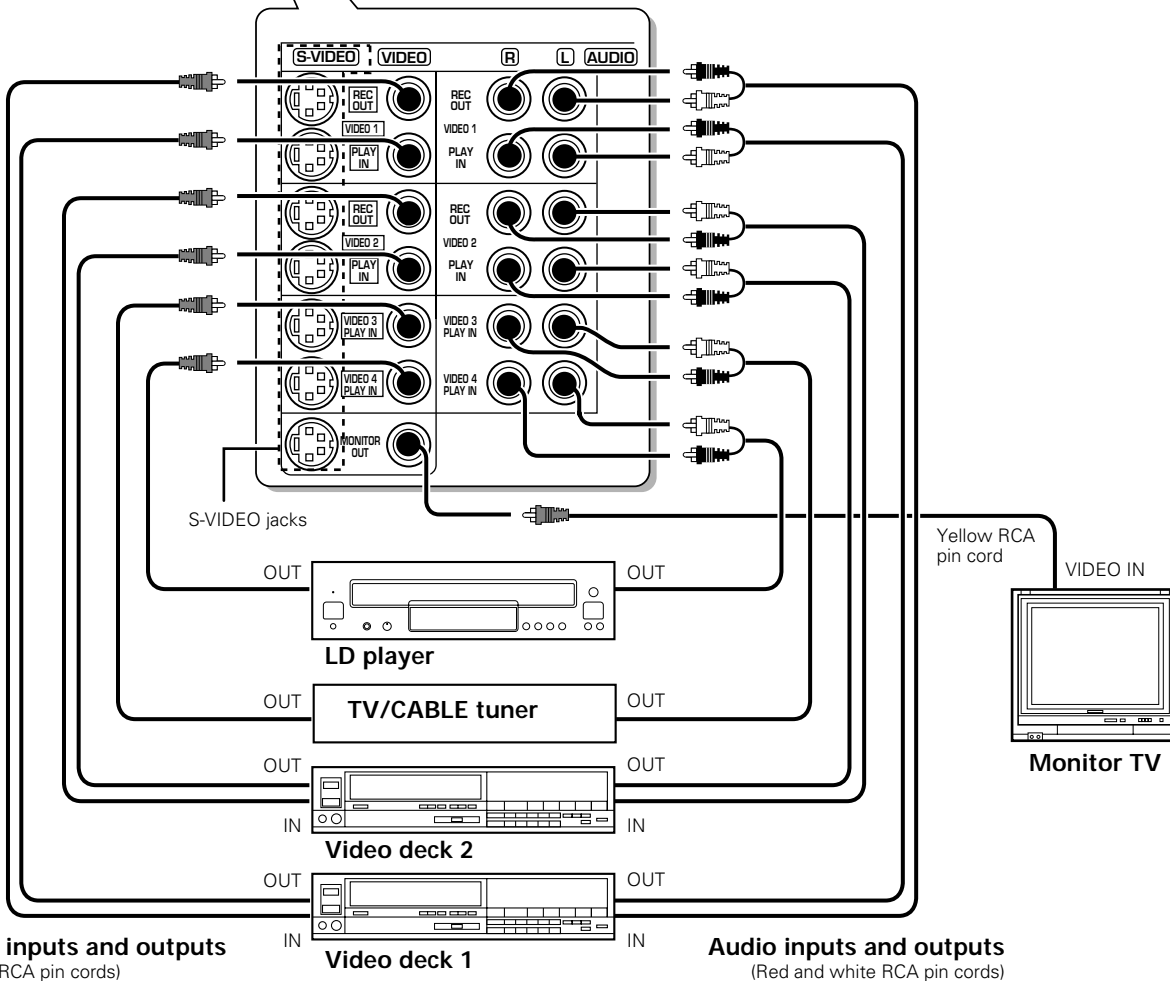

Video inputs and outputs
(Yellow RCA pin cords)

Audio inputs and outputs
(Red and white RCA pin cords)

Digital connections

Make connections as shown below.

The digital in jacks can accept either Dolby Digital (AC-3) or PCM signals (the input signal type is detected automatically). When connecting the related system components, be sure to also refer to the instruction manuals supplied with the components you are connecting.

Do not connect the power cord to a wall outlet until all connections are completed.

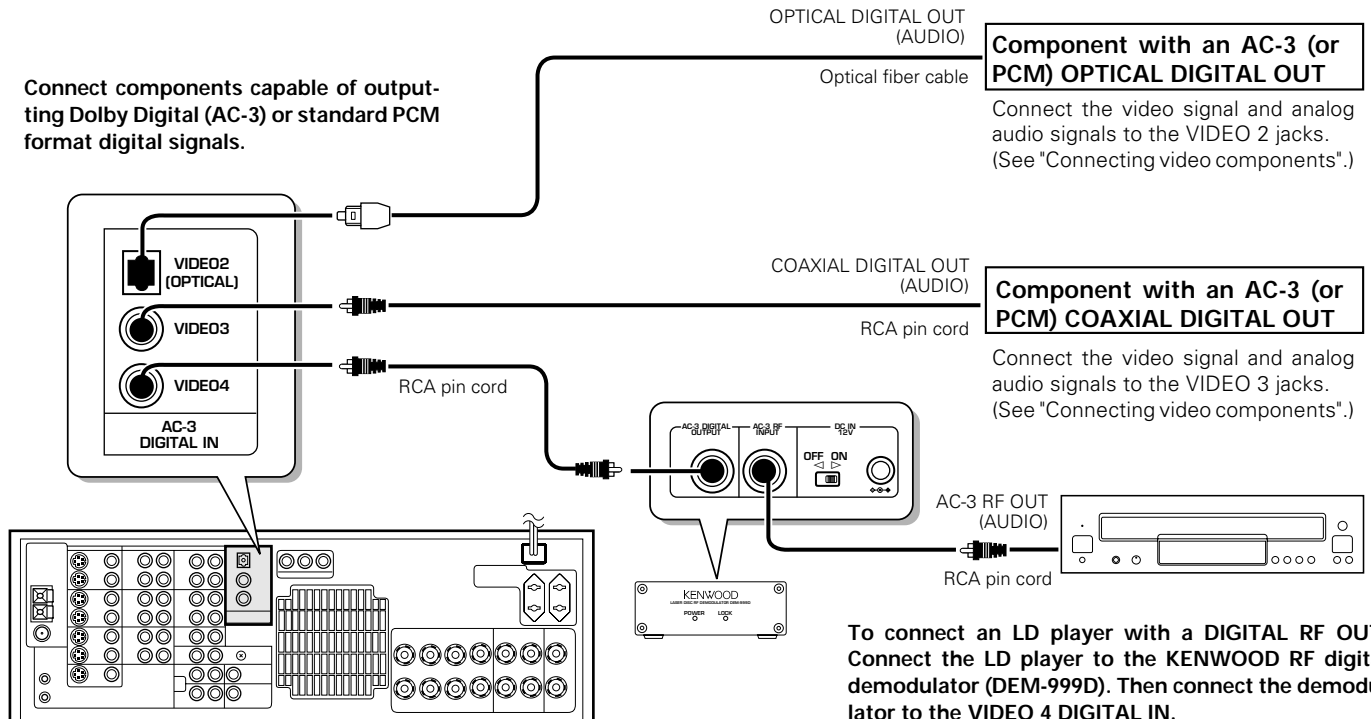

Component with an AC-3 (or PCM) OPTICAL DIGITAL OUT
Connect the video signal and analog audio signals to the VIDEO 2 jacks. (See "Connecting video components".)

Component with an AC-3 (or PCM) COAXIAL DIGITAL OUT
Connect the video signal and analog audio signals to the VIDEO 3 jacks. (See "Connecting video components".)

To connect an LD player with a DIGITAL RF OUT. Connect the LD player to the KENWOOD RF digital demodulator (DEM-999D). Then connect the demodulator to the VIDEO 4 DIGITAL IN. Connect the video signal and analog audio signals to the VIDEO 4 jacks. (See "Connecting video components".)

AC-3 RF Demodulator DEM-999D



- 1 POWER indicator**
Lights (red) when the power switch (5) is set to ON.
- 2 LOCK indicator**
Lights when an AC-3 RF signal is input to the AC-3 RF INPUT jack (4).
- 3 AC-3 DIGITAL OUTPUT (coaxial)**
Connect this jack to the coaxial AC-3 DIGITAL IN jack on your receiver. It outputs AC-3 coaxial digital signals when the POWER (5) is set to ON and an AC-3 RF signal is input to the AC-3 RF INPUT jack (4).

- 4 AC-3 RF INPUT**
Connect this jack to the AC-3 RF OUTPUT jack on your LD player.
- 5 POWER switch**
Use to switch the power ON/OFF.
- 6 DC IN (12V) jack**
Connect this jack and inlet power cord to the AC adaptor supplied with your demodulator. Connect the power cord to a wall outlet after completing all of the other connections.

Place the power supply away from the demodulator, receiver, and any antennas.

1 2 Connecting the system control

Preparations

Connecting system control cords after connecting a KENWOOD audio component system lets you take advantage of convenient system control operations. There are two KENWOOD system control modes. Make connections according to the groups of terminal symbols shown below.

[XS8] Mode : lets you combine [XS], [XS8], and [XR] terminals

[SL16] Mode : for [SL16] terminals only

This unit is compatible with both [XS8] and [SL16] modes. It comes from the factory set to the [SL16] mode. To switch to the [XS8] mode, follow the instructions in "SWITCHING FROM [SL16] TO [XS8]" below.

EXAMPLE: [XS8] mode connections

The underlined portion represents the setting of the system control mode.

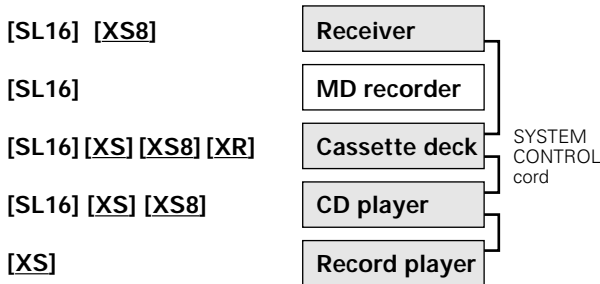

EXAMPLE: [SL16] mode connections

The underlined portion represents the setting of the system control mode.

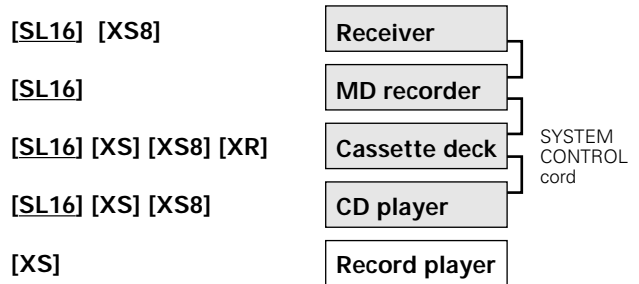

- In order to take advantage of the system control operations, the components must be connected to the correct jacks. To use a CD player it must be connected to the CD jacks. To use a cassette deck (or MD recorder) it must be connected to the TAPE1/MD jacks. When using more than one CD player (etc.) only the one connected to the specified jacks may be connected for system control.
- Some CD players and cassette decks are not compatible with the [SL16] system control mode. Be sure to use the [XS8] system control mode when making system connections with equipment that is not [SL16] compatible.
- Some MD players are not system control compatible. You cannot make system control connections to this kind of equipment.



1. [SL16] equipment cannot be combined with [XR], [XS], and [XS8] equipment for system operations. If your equipment consists of this kind of combination, please do not connect any system control cords. Even without system control cords, normal operations can be carried out without effecting performance.
2. Do not connect system control cords to any components other than those specified by KENWOOD. It may cause a malfunction and damage your equipment.
3. Be sure the system control plugs are inserted all the way in to the system control terminals.

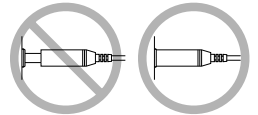

SYSTEM CONTROL OPERATIONS

Remote Control

Lets you operate this unit with the system remote supplied with the receiver.

Automatic Operation (except [XR] equipment)

When you start playback from a source component, the input selector on this unit switches to that component automatically.

Synchronized Recording (except [XR] equipment)

Lets you synchronize recording with the start of playback when recording from CD, MD or analog discs.

SWITCHING FROM [SL16] TO [XS8]

You can easily change the system control mode by adjusting the position of the SYSTEM CONTROL switch on the rear panel. Do this operation after completing all connections.

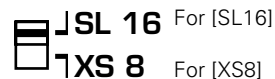

- This operation will not effect items stored in the memory.
- After switching the system control mode, turn the power off and then on once to confirm the new setting.

Registering setup codes for KENWOOD audio components

- Once you finish making the system connections, be sure to register the appropriate setup code for each component. → 40
- If you own remote controllable KENWOOD audio components that are not compatible with system control (or cannot be combined with your other system control components), registering the setup code enables you to control those components using the remote control supplied with this unit (without connecting system control cords). To register setup codes for your remote controllable KENWOOD audio components, see "Registering setup codes for other components". → 40

Connecting the speakers

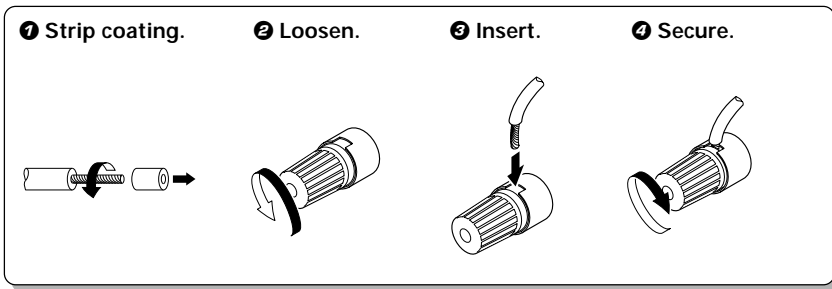

- Never short circuit the + and – speaker cords.
- If the left and right speakers are connected inversely or the speaker cords are connected with reversed polarity, the sound will be unnatural with ambiguous acoustic imaging. Be sure to connect the speakers correctly.

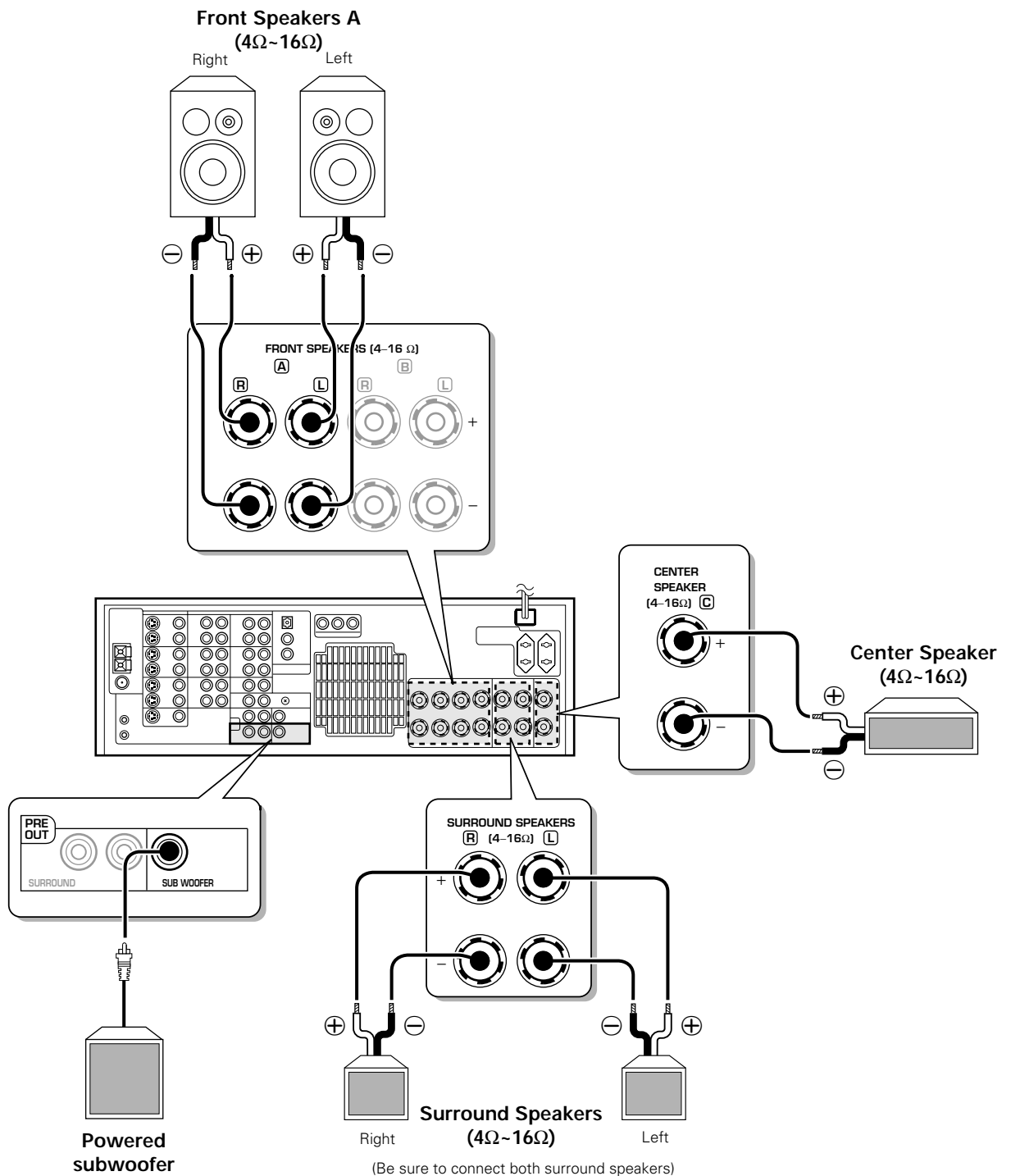

PRE OUT connections

This receiver has additional preout jacks. These can be used for various purposes, but will need to be connected to an external power amplifier as shown in the example below. Connecting a speaker cord directly to a PRE OUT jack will not produce any sound from the speaker.

Be sure to set the SPEAKERS A key to the ON position when using the PRE OUT jacks in Room A.

No sound is output from the SUBWOOFER jack when the SPEAKERS A key is set to the OFF position.

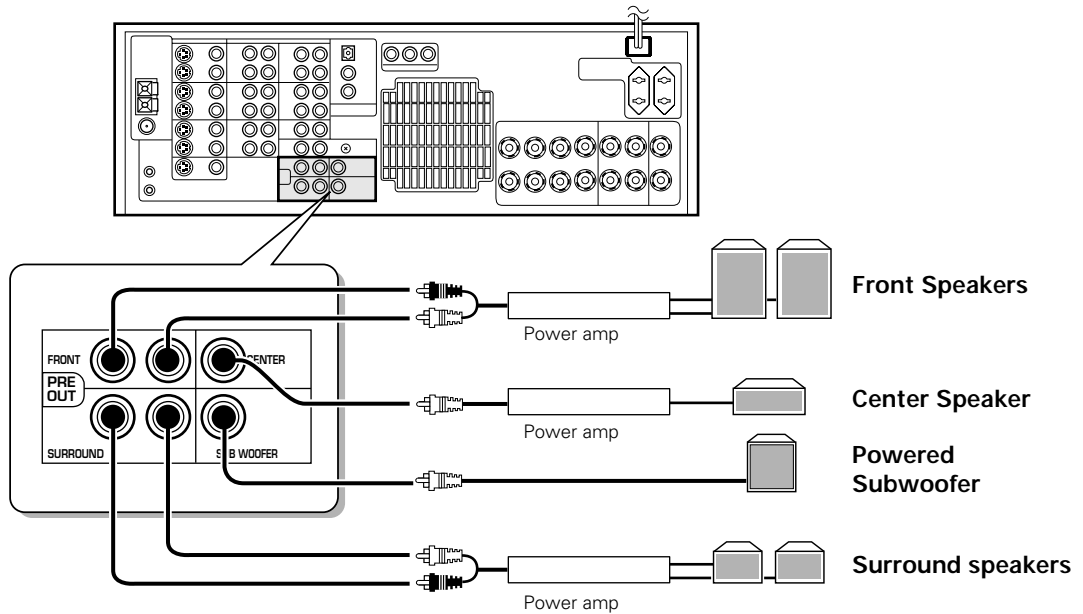

Making connections to another room (ROOM B)

The following connections allow you to connect your main system to a monitor TV and speaker system located in another area (ROOM B). The monitor TV can be connected directly to the SECOND ROOM PRE OUT VIDEO jack. To connect the speakers, use either of the connections described below.

To select the input and adjust the volume (etc.) for your other area (ROOM B), set the remote control to the ROOM B operation mode. → 47

FRONT SPEAKERS B connections (1):

These connections allow you to connect the speakers in ROOM B directly to the receiver without using an additional power amplifier. The sound from the main system (ROOM A) automatically switches to stereo when SPEAKERS B are turned on. → 47

SECOND ROOM PRE OUT connections (2):

Use these connections if you want to enjoy surround sound from your main system (ROOM A) while outputting another source to ROOM B. Connecting a speaker cord directly to a SECOND ROOM PRE OUT jack will not produce any sound from the speaker. Connect the SECOND ROOM PRE OUT jacks to powered speakers or power amplifiers connected to speakers.

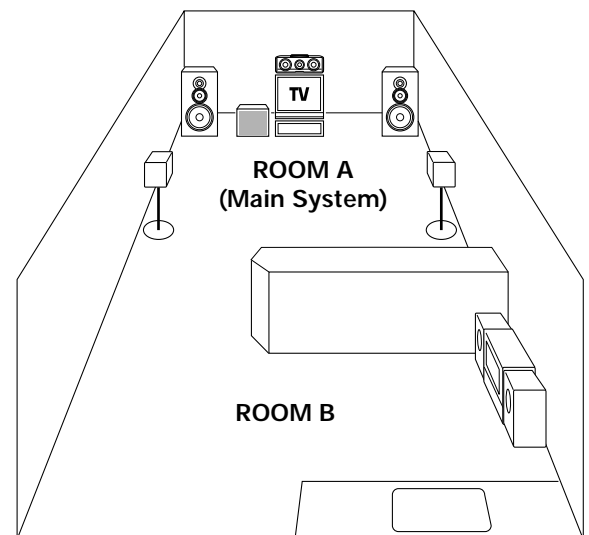
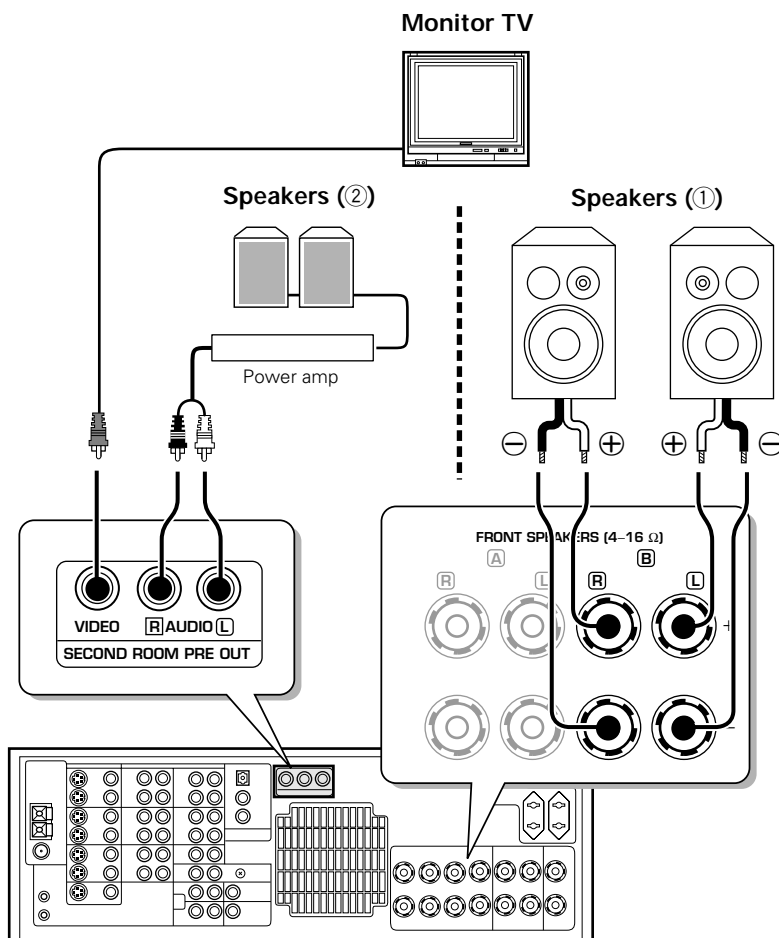

1 6 Preparing the remote control

Loading the batteries

1 Remove the cover.

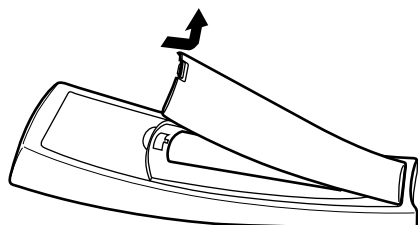

2 Insert the batteries.

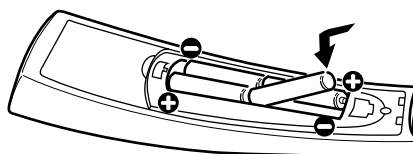

3 Close the cover.

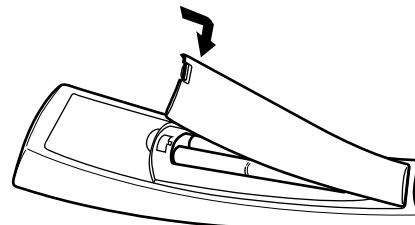

• Insert four AAA-size (LR03) batteries as indicated by the polarity markings.



1. The supplied batteries may have shorter lives than ordinary batteries due to use during operation checks.
2. Replace all four batteries with new ones when you notice a shortening of the distance from which the remote control will operate or if the remote control blinks 5 times when you push a key. The remote control is designed to retain set up codes in memory while you change batteries.
3. Placing the remote sensor in direct sunlight, or in direct light from a high frequency fluorescent lamp may cause a malfunction. In such a case, change the location of the system installation to prevent malfunction.

Operating distance

This remote control has two IR emitters: one to send commands in a straight line over long distances, allowing you to control the receiver and your other components from farther away; and one for wide dispersion of commands in a closer proximity, for near-field operation even when the remote control is not pointed directly at the respective component.

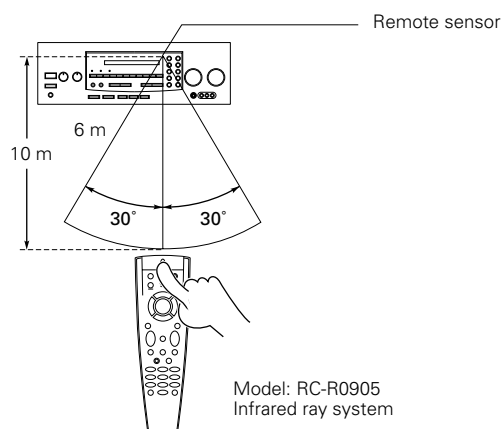

Preparing for surround sound

This receiver incorporates an on screen display (OSD) feature to simplify the surround setup procedure by providing large easy to read graphic information. The section below shows you how to operate the on-screen display. Read this first before going on to the surround setup procedures on the following pages.

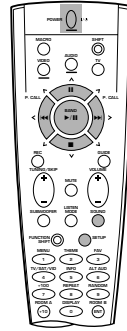

Keys or controls used in this operation.

Preparations

- Set the **POWER** key to ON.
- Set the **ON/STANDBY** key to ON.
- Turn on your monitor TV.

Using the on-screen display

On-screen operations consist of moving the arrow icon to select items from the screen.

1 Press the **SOUND** or **SETUP** key.

Pressing either the **SOUND** or **SETUP** key automatically activates the on-screen display

SOUND **SETUP**

- The remote control automatically switches to OSD remote control mode when an on-screen display appears in your monitor TV.

2 Move the pointer.

It can be moved in 8 directions, depending on how you press the keys

EXAMPLE: moving the pointer to an icon at right.

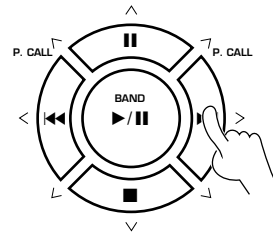

EXAMPLE: when the pointer is moved to the DSP command.



Press the > key.

- If no icons are located in the direction you pressed, the pointer may move in a different direction to locate the nearest object.

3 Press the item you desire.

- To confirm an item, press the **BAND (▶/||)** key located in the center of the remote control after moving the pointer to the item you want to select.

The DSP screen appears.

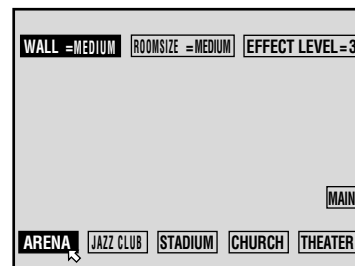

To quit the OSD mode:

- 1 Press the **SOUND** or **SETUP** key again.
- 2 Press either the **VIDEO**, **AUDIO**, or **TV** key to cancel the OSD remote control mode.

1 8 Surround set up

To obtain the best possible enjoyment from the receiver's various surround modes, be sure to complete the surround set up as shown below.

1 Speaker placement.

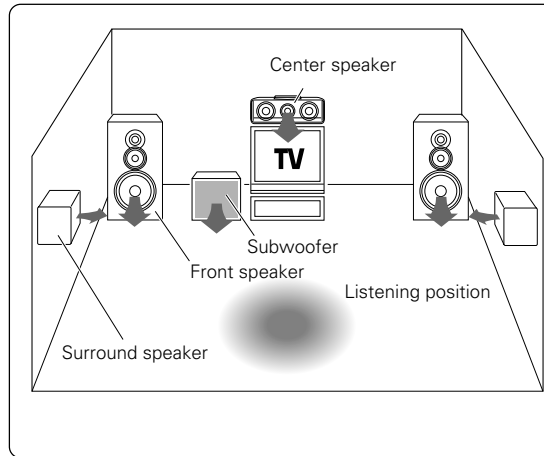

Front speakers : Place to the front left and right of the listening position. Front speakers are required for all surround modes.

Center speaker : Place front and center. This speaker stabilizes the sound image and helps recreate sound motion. Be sure to connect a center speaker when using the Dolby 3 Stereo mode.

Surround speakers : Place to the direct left and right, or slightly behind, the listening position at even heights, approximately 1 meter above the ears of the listeners. These speakers recreate sound motion and atmosphere. Required for surround playback.

Subwoofer : Reproduces powerful deep bass sounds.

• Although the ideal surround system consists of all the speakers listed above, if you don't have a center speaker or a subwoofer, you can divide those signals between the available speakers in the following steps to obtain the best possible surround reproduction from the speakers you have available.

2 Go to the SP.SLCT (speaker select) page of the SET UP screen.

• Pressing the **MAIN** icon lets you access the main sound menu. → 36

3 Select the speakers and enter the speaker distance.

- ① **Specify the type of speakers you connected to the receiver.**
 - ① Move the pointer downward (icon turns blue).
 - ② Use the **TUNING/SKIP** keys to specify the setting you desire.
 - ③ Press the **BAND** (▶/||) key to confirm the setting (icon turns yellow).
 - ④ Repeat steps ② and ③ to specify a setting for each speaker type.
 - Be sure to specify settings for each speaker type before continuing to the next screen.

SW : Subwoofer
 ON: Select when using a subwoofer.
 OFF: Select when not using a subwoofer.

L R : Front speakers (left and right)
 SML (small): Select when using a relatively small front speakers.
 LRG (large): Select when using a relatively large front speakers.

C : Center speaker
 SML (small): Select when using a relatively small center speaker.
 LRG (large): Select when using a relatively large center speaker.
 OFF: Select when not using a center speaker.

S : Surround speakers (left and right)
 SML (small): Select when using a relatively small surround speaker.
 LRG (large): Select when using a relatively large surround speaker.
 OFF: Select when not using surround speakers.
- ② **Continue to the SP.LVL (speaker level) screen.**

4 Adjust the volume levels of each speaker.

Listen to the test tone and adjust the volume level of each speaker so that they all produce the test tone at the same volume level.

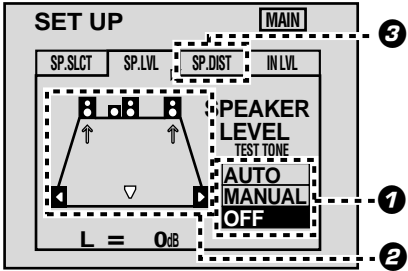

- 1 Select the test tone type.**
 AUTO : The test tone switches between each speaker in regular intervals.
 MANUAL : The test tone only comes from the selected speaker (displayed in blue).
 OFF : Stops the test tone.
- 2 Adjust the Volume level of each speaker.**
 ① Listen to the test tone and select the speaker you want to adjust.
 • The selected speaker icon turns blue and the speaker name and level appear (at the bottom of the screen) to show that it can be adjusted.
 ② Listen to the test tone and adjust the volume level of the speaker (± 10 dB) using the **TUNING/SKIP** keys on the remote control.
TUNING/SKIP - : Lowers the volume **TUNING/SKIP +** : Raises the volume
 • Adjust the subwoofer as you desire.
- 3 Continue to the SP.DIST (speaker distance) screen.**

5 Enter the speaker distance.

Enter the distance from your listening position to the front (left or right), center, and rear (left or right) speakers. If both front (or rear) speakers are not the same distance from the listening position, enter the distance to the closest speaker.

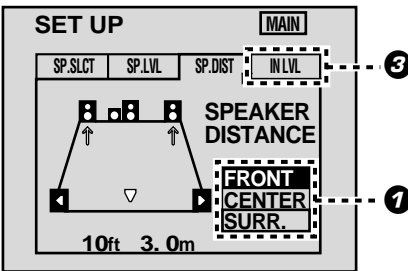

- 1 Select the speaker.**
 The speaker name turns blue. An arrow icon appears to indicate the selected speaker.
- 2 Enter the speaker distance.**
 Use **TUNING/SKIP** on the remote control to select the appropriate distance.
 The distance is adjustable from 0.0meters (0 feet) to 9.0meters (30 feet) in 0.3meter (1 foot) steps.
- 3 Continue to the IN LVL (input level) screen.**

6 Adjust the audio input level of the connected components.

The LEVEL INDICATOR lights during playback if the signal being input from an analog source is too large. If this occurs, use this screen to attenuate the input level for that source.

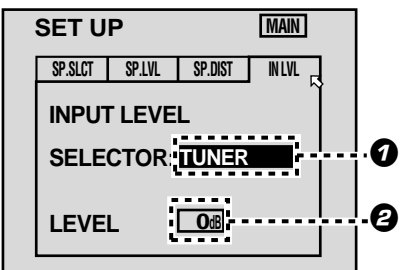

- 1 Select the input.**
 ① Use **TUNING/SKIP** on the remote control to select the desired input.
 ② Move the pointer downward.
- 2 Select an input level.**
 The input level is adjustable in 3 levels. Use **TUNING/SKIP** on the remote control to select the smallest level required to extinguish the LEVEL INDICATOR (normally, set to 0 dB).
 0 dB \leftrightarrow -3 dB \leftrightarrow -6 dB
- 3 Press the SETUP key on the remote to turn off the on-screen display.**
- 4 Press either VIDEO, AUDIO, or TV key on the remote to cancel the OSD remote control mode.**

This completes the surround setup.

Normal playback

KR-V999D (En/T)

2 0

- Preparations**
- Turn on the power to the related components.
 - Set the **POWER** key to the ON position.

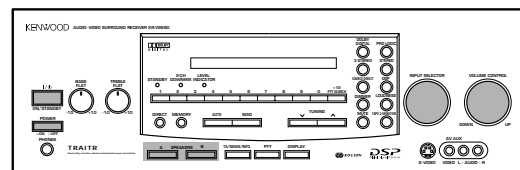
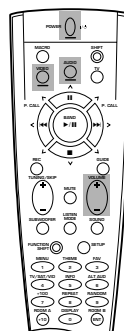
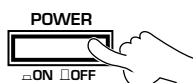

Keys or controls used in this operation.

Listening to a source component

- 1** Turn on the receiver.

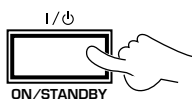
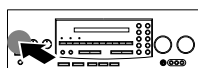

- 2** Set **SPEAKERS A** to on.

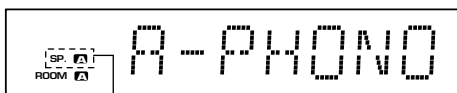
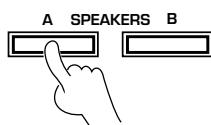

The speaker A indicator should be lit.

- 3** Select the source you desire.

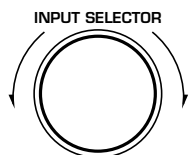
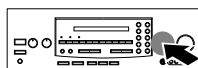

- 4** Start playback from the selected source.

- 5** Adjust the volume.

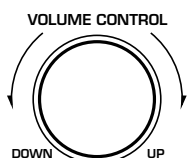
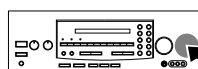

Decrease volume

Increase volume

- Surround modes cannot be activated when both **SPEAKERS A** and **SPEAKERS B** are set to ON. For details on the **SPEAKERS B** button, see "Controlling the sound in another room (ROOM B)". → 47
- Be sure to set the **SPEAKERS A** key to the ON position when using the PRE OUT jacks in Room A. No sound is output from the SUBWOOFER jack when the **SPEAKERS A** key is set to the OFF position.

The input sources change as shown below:

- ① TUNER (Frequency display)
- ② "PHONO" ("PHONO"*)
- ③ "VIDEO1" ("SAT"*)
- ④ "VIDEO2" ("LD"*)
- ⑤ "VIDEO3" ("VCR"*)
- ⑥ "VIDEO4" ("DSS"*)
- ⑦ "AV AUX"
- ⑧ "CD" ("CD"*)
- ⑨ "TAPE1/MD" ("TAPE"*)

* Once setup codes are registered in the remote control, the input name display changes according to the name of the registered component. Example: if you register a VCR at the VIDEO 1 jacks, "VCR1" appears instead of "VIDEO 1". → 40

- Both the default input name and the component type (i.e., "VIDEO1 'VCR1' ") are shown in the on screen display when the OSD mode is set to ON.
- When using the remote control after initial setup, any inputs that have not been registered with a setup code are deleted from the cyclic list (except for the "AV AUX" VIDEO input). → 42
- The **INPUT SELECTOR** on the front panel of the receiver always cycles through all inputs.

Volume display

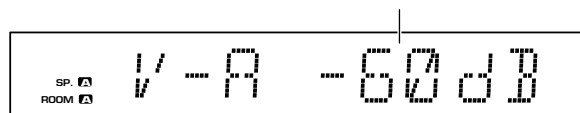

Operations

To adjust the balance

Use the test tone feature.

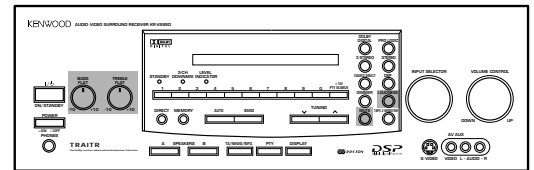
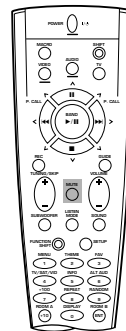

Keys or controls used in this operation.

Adjusting the sound

Adjusting the tone

Frequency weighting (LOUDNESS)

LOUDNESS lets you emphasize the sound of frequencies that are difficult to hear. The frequency emphasis varies according to the volume at which you are listening.

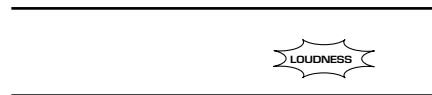

To cancel

Press again.

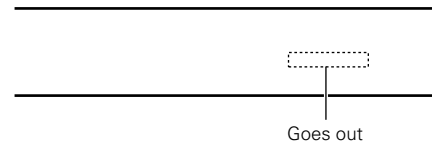

Muting the sound

MUTE lets you mute the sound of the speakers.



Blinks when muting the sound in ROOM A

To cancel

Press again.

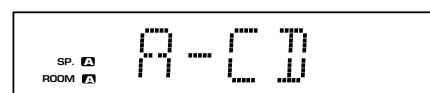

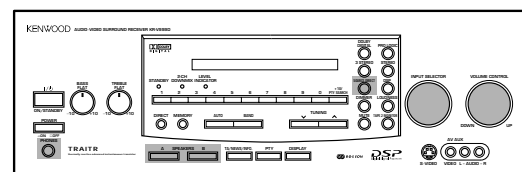
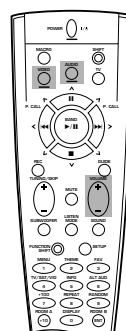

- The mute button on the receiver allows you to mute the sound from the speakers in ROOM A.
- The remote control lets you mute the sound from the speakers in ROOM A and/or ROOM B depending on the current control mode.



Keys or controls used in this operation.

SOURCE DIRECT playback

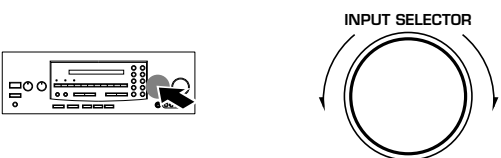
Use this function to pass the source material direct to the amplifier, bypassing any audio processing.

- 1 Select a playback source.
 
- 2 Press the SOURCE DIRECT key.
 
- 3 Start playback .

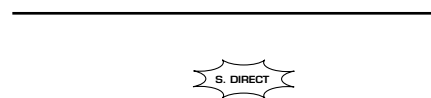

- Tone controls do not work during SOURCE DIRECT playback.
- Pressing the **STEREO** key or any of the keys related to surround playback will cancel SOURCE DIRECT playback.
- You can also select S.DIR (source direct) from the on-screen display (SOUND menu).

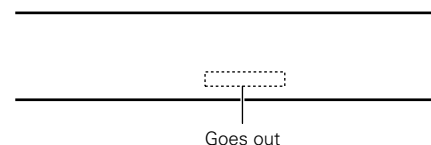

To cancel

Press again.

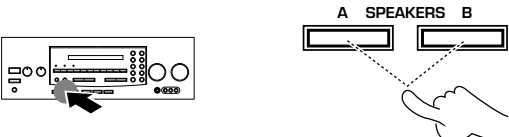

- If SOURCE DIRECT playback was activated when using a surround mode, cancelling it reactivates the previous surround mode.

Listening with headphones

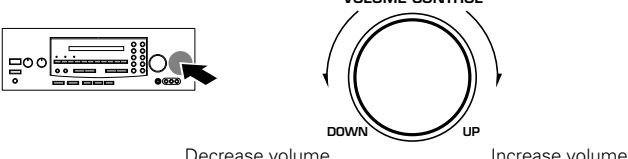
- 1 Turn OFF both speaker switches.
 
- 2 Connect headphones.
 
- 3 Adjust the volume.
 

Decrease volume Increase volume

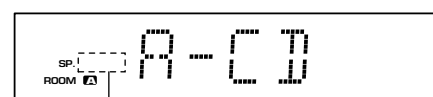

Make sure the SPEAKERS indicators are turned off.

- Turning off both **SPEAKERS A** and **B** when using a surround mode will cancel the respective mode and activate stereo playback.

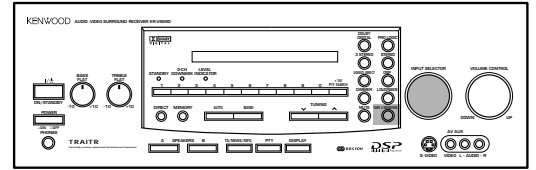
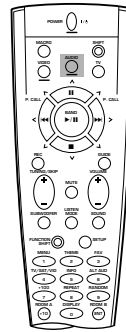

Keys or controls used in this operation.

Recording audio

Recording a music source

- 1 Select the source you want to record.



Select a source other than TAPE 1

- 2 Set the cassette deck to record.
- 3 Start playback, then start recording.

- To record a digital source, connected to the VIDEO 2, 3, or 4 jacks, turn the **INPUT SELECTOR** to select the appropriate component, then press the **STEREO** key. When making a digital recording, operations other than volume adjustment may cause the sound to clip during recording.

Dubbing tapes (TAPE 2 → TAPE 1)

- 1 Press **TAPE 2 MONITOR**.



- 2 Set the input selector to a source other than TAPE 1.



- 3 Start playback from TAPE 2, then start recording on TAPE 1.

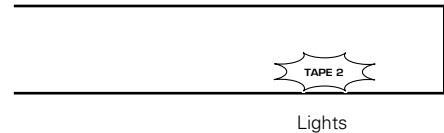

- When copying with a double cassette deck, refer to the operating instructions supplied with the deck.

Dubbing tapes (TAPE 1 → TAPE 2)

- 1 Set the **INPUT SELECTOR** to TAPE 1.
- 2 Start playback from TAPE 1, then start recording on TAPE 2.

TAPE 2 MONITOR function

You can connect either a cassette deck or a graphic equalizer to the receiver's TAPE 2 jacks. If you connect a graphic equalizer, the **TAPE 2 MONITOR** key should be turned ON. If you connect a 3-head cassette deck, you can compare the source sound to the sound being recorded while recording. Press the **TAPE 2 MONITOR** key to switch between the recorded sound to the source sound. For further details, refer to the operating instructions supplied with the component you connected.

The TAPE 2 MONITOR function cannot be used when making digital recordings.

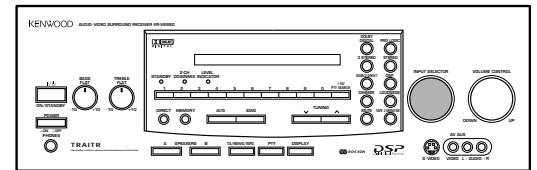
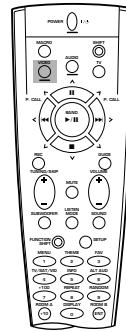

Keys or controls used in this operation.

Recording video

- 1 Select the source you want to record.

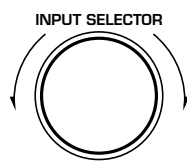
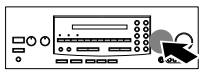

- 2 Set the video deck to record.
- 3 Start playback, then start recording.

- When recording to a VCR connected to the VIDEO1 jacks, select a source other than VIDEO1.
- When recording to a VCR connected to the VIDEO2 jacks, select a source other than VIDEO2.
- To record a digital source, connected to the VIDEO 2, 3, or 4 jacks, turn the **INPUT SELECTOR** to select the appropriate component, then press the **STEREO** key.
When making a digital recording, operations other than volume adjustment may cause the sound to clip during recording.
- The AV AUX jacks on the front panel provide a convenient way to connect a video camera (playback only).
- When recording a Dolby Digital (AC-3) source, press the **STEREO** key to light the "2 CH DOWNMIX" indicator.

Listening to radio broadcasts

Radio stations can be classified into RDS (Radio Data System) stations and other stations. To listen to or store RDS stations in the preset memory, see the section entitled, "Using RDS".

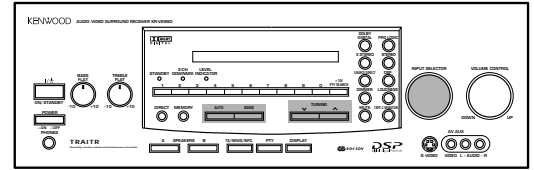
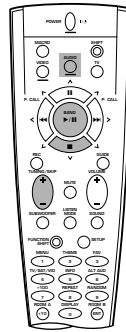

Keys or controls used in this operation.

Tuning (non-RDS) radio stations

1 Set the input to tuner.

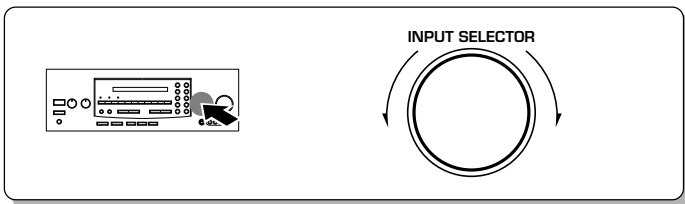

Frequency display



2 Select a broadcast band.

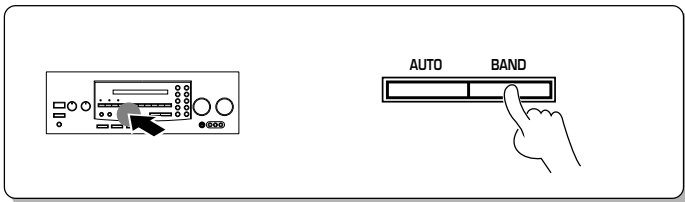

Each press switches the band as follows:

- ① FM
- ② AM

"AM" or "FM" indicator



3 Select a tuning method.

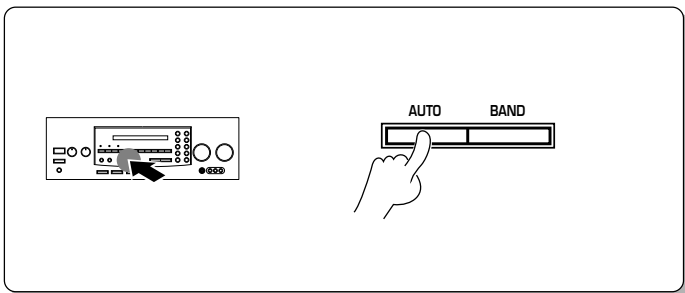

Each press switches the tuning method as follows:

- ① AUTO lit (auto tuning)
- ② AUTO not lit (manual tuning)

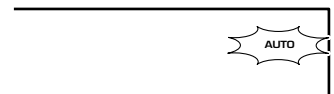

- Normally, set to "AUTO" (auto tuning).
- If the radio waves are weak and there is a lot of interference, switch to manual tuning. (With manual tuning, stereo broadcasts will be received in monaural.)

4 Select a station.

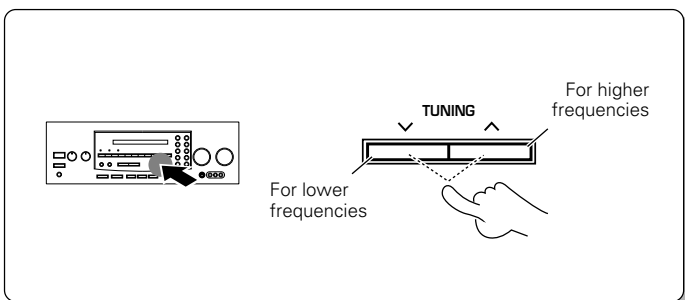

Frequency display



"TUNED" is displayed when a station is received

- Auto tuning : The next station is tuned automatically.
- Manual tuning : Press repeatedly or hold to tune the station.

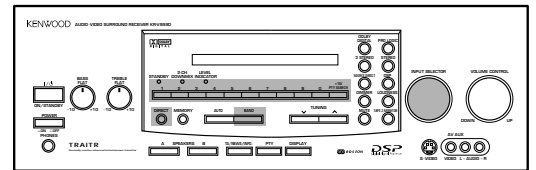
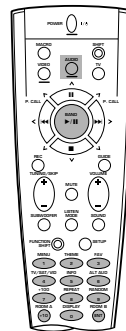

Keys or controls used in this operation.

Tuning radio stations by frequency (DIRECT tuning)

1 Set the input to tuner.

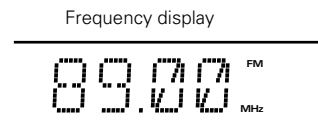
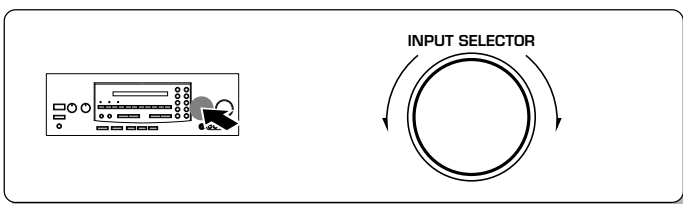

2 Select a broadcast band.

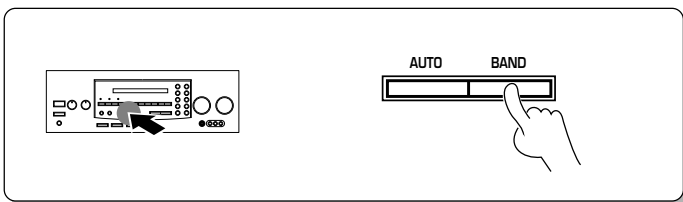

Each press switches the band as follows:

- ① FM
- ② AM

"AM" or "FM" is displayed



3 Enter the frequency.

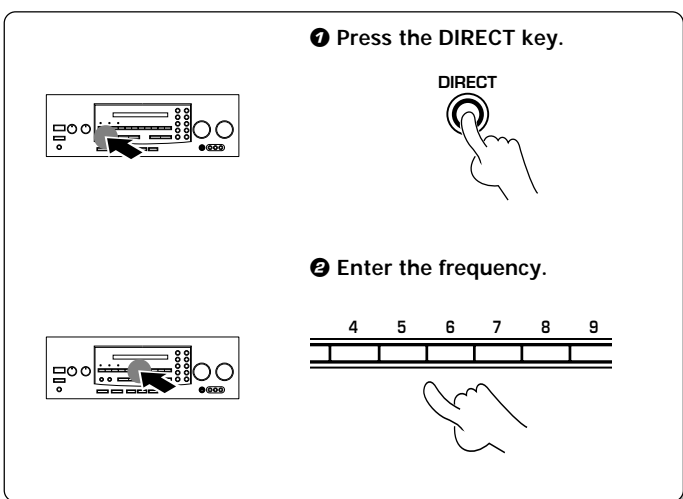

Press the numeric keys according to the frequency to be tuned as shown below:

- AM 810 kHz, press **8**, **1**, **0**
- AM 1260 kHz, press **1**, **2**, **6**, **0**
- FM 90 MHz, press **9**, **0**, **0**, **0**
- FM 102.5 MHz, press **1**, **0**, **2**, **5**, **0**

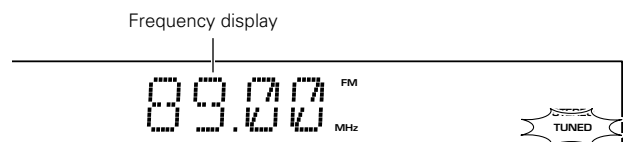

"TUNED" is displayed when a station is received

- If you make a mistake entering the frequency, the frequency display will blink for a few seconds. In this case, start again from step **2**.

Using RDS (Radio Data System)

RDS is a system that transmits useful information (in the form of digital data) for FM broadcasts along with the broadcast signal. Tuners and receivers designed for RDS reception can extract the information from the broadcast signal for use with various functions, such as automatic display of the station name.

RDS functions:

PTY (Program Type Identification) Search: → 30

Automatically tunes to a station that is currently broadcasting the specified program type (genre).

EON (Enhanced Other Network) reservation → 32

Sets the tuner to automatically switch to stations broadcasting one of three types of programs, even though you are listening to another station. The tuner returns to the original station when the broadcast of the selected program ends.

PS (Program Service Name) Display: See figure ① below.

Automatically displays the station name transmitted by the RDS station.

RDS Auto Memory function → 28

Automatically selects and stores up to 40 RDS stations in the preset memory.

Radio text function: See figure ③ below.

Displays the radio text data transmitted by some RDS stations when you press the **DISPLAY** key. There is no display if no text data was transmitted.

Radio text can also be displayed on the on screen display using the OSD functions.

The "RDS" indicator lights up when an RDS broadcast (signal) is received.



Some functions and function names may differ for certain countries and areas.

Before using a function utilizing the RDS, be sure to perform the RDS Auto Memory operation by referring to the description in "Presetting RDS stations (RDS AUTO MEMORY)". → 28

Using the DISPLAY key

Pressing the DISPLAY key changes the contents of the display.



Each press switches the display mode as follows:

- ① PS (Program Service name) display
- ② Frequency display
- ③ RT (Radio Text) display

① PS (Program Service name) display:

The station name is displayed automatically when an RDS broadcast is received. If no PS data was sent, "NO PS" is displayed.

② Frequency display:

Displays the frequency of the current station.

③ RT (Radio Text) display:

Text data accompanying the RDS broadcast scrolls across the display. "NO RT" is displayed if the current RDS station does not provide RT data. Radio text can also be displayed on the on screen display using the OSD functions.

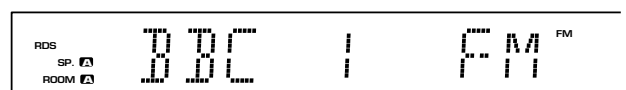

Before listening to an RDS broadcast, follow the instructions below to store the RDS stations in the preset memory. Up to 40 stations can be preset, and then received with the touch of a single button.

This receiver uses the Radio Data System (RDS) to provide convenient tuning functions like PTY search and EON reservation.

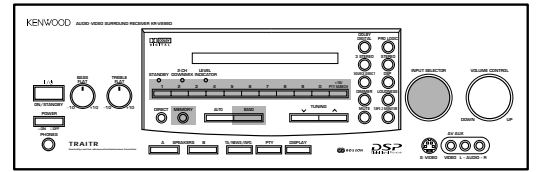
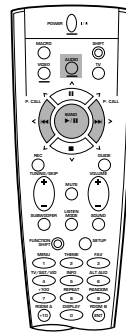

Keys or controls used in this operation.

Presetting RDS stations (RDS AUTO MEMORY)

This function automatically stores up to 40 RDS stations in the preset memory. In order to use the EON and PTY functions, the RDS stations must be stored in the preset memory using the RDS AUTO MEMORY function.

1 Set the input to tuner.

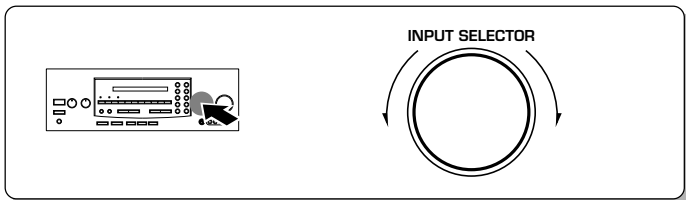

2 Set the broadcast band to "FM".

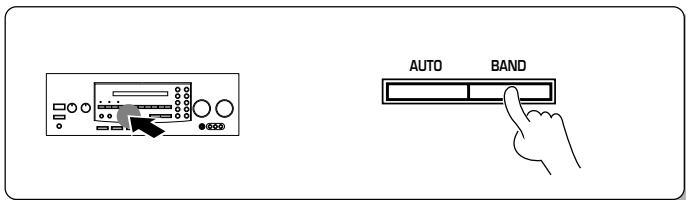

Each press switches the band as follows:

- ① FM
- ② AM

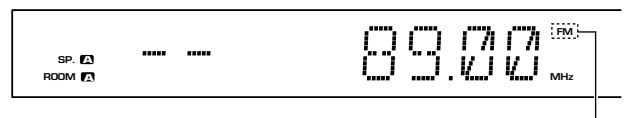

"FM" is displayed

3 Store the stations automatically.

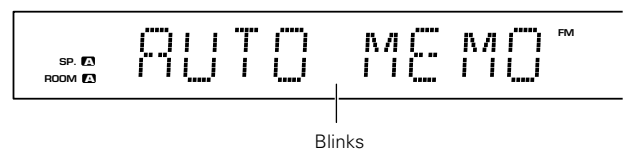
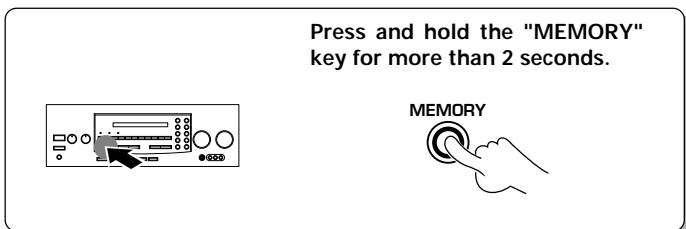

- After a few minutes, up to 40 RDS stations are preset in order from channel "01".
- Stations already stored in the preset memory may be replaced by RDS stations. (i.e., If the RDS AUTO MEMORY function finds 15 RDS stations, the stations currently preset at numbers 01~15 are replaced by the RDS stations.)

Receiving preset RDS stations

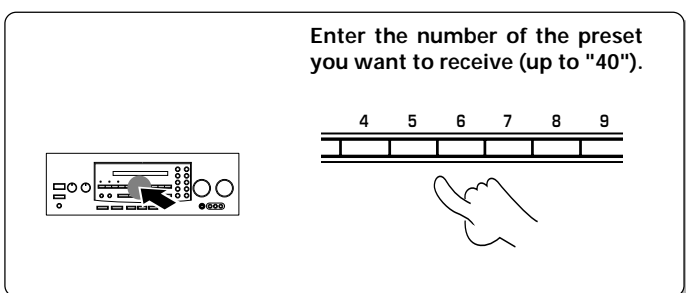

Press the numeric keys in the following order:

For "15", press **+10**, **5**

For "20", press **+10**, **+10**, **0**

- If you make a mistake entering a two digit number, press the **+10** key several times to return to the original display and start again.
- To change the information in the display, press the **DISPLAY** key.



The RDS auto memory function assigns preset numbers to RDS stations starting from preset number "1". Therefore, be sure to execute the RDS auto memory function before using the following operations to manually store AM stations and other FM stations, and RDS stations.

"Presetting RDS stations (RDS AUTO MEMORY)". → 28

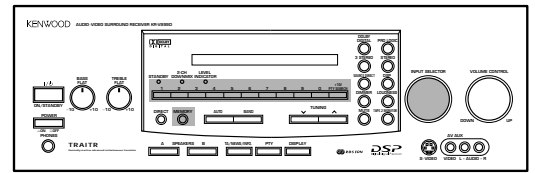
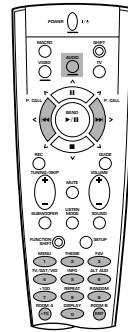

Keys or controls used in this operation.

Preparation • Select tuner.

Presetting radio stations manually

➊ Tune to the station you want to store.

➋ Press the MEMORY key while receiving the station.

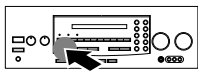

MEMORY



Proceed to step ➌ within 5 seconds. (If more than 5 seconds elapse, press MEMORY again).

➌ Enter a preset number (1-40).

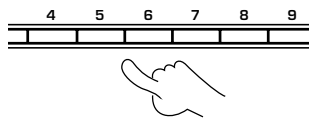

- In addition to the RDS auto memory function, RDS stations can also be stored manually in the preset memory.
- When storing radio stations manually, it may take a few minutes before the "MEMORY" indicator appears in the display after pressing the MEMORY key depending on receiving conditions.

Blinks for 5 seconds

Lights for 5 seconds

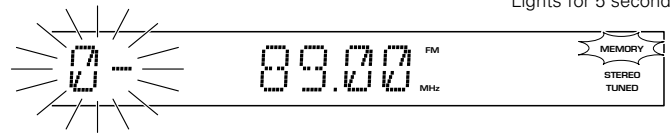

Press the numeric keys in the following order:

For "15", press **+10**, **5**

For "20", press **+10**, **+10**, **0**

- Repeat steps ➊, ➋ and ➌ to store as many stations as necessary.
- If you store a station at a previously used preset, the old station will be replaced by the new one.
- When RDS stations are stored manually in the preset memory, the PS information may not be included in the memory depending on receiving conditions.

Receiving preset stations

➊ Select tuner.



INPUT SELECTOR



➋ Enter the number of the preset you want to receive (up to "40").

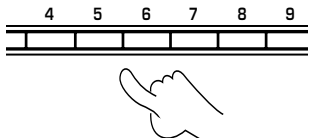

Press the numeric keys in the following order:

For "15", press **+10**, **5**

For "20", press **+10**, **+10**, **0**

- If you make a mistake entering a two digit number, press the +10 key several times to return to the original display and start again.

Preset number stored in memory



Receiving preset stations in order (P.CALL)

When using the remote control, press AUDIO to select the tuner control mode.

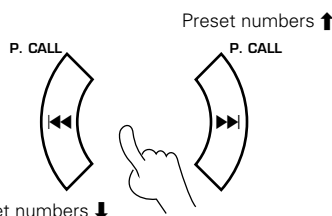
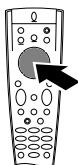

- Each time you press the key, another preset station is received in order.

When you press **▶▶**

1→2→3→ . . . 38→39→40→1→2→3→

When you press **◀◀**

1←2←3← . . . 38←39←40←1←2←3←

Holding down the button, lets you skip through the presets, receiving each for 0.5 seconds apiece.

30

This function lets you set the tuner to automatically search for stations which are currently broadcasting the type of program (genre) you want to listen to.

Under adverse receiving conditions, it may take more than 1 minute to complete the search.

- Preparations**
- Execute the RDS auto memory procedure.
 - Set the broadcast band to **FM**.
 - Tune to an RDS station.

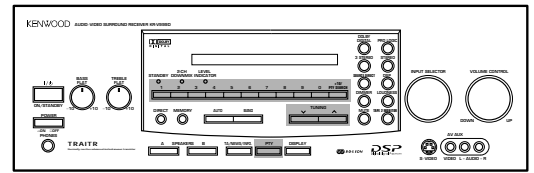
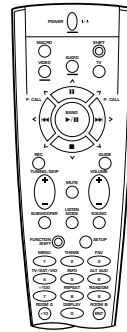

Keys or controls used in this operation.

Tuning by program type (PTY search)

1 Activate the PTY search mode.

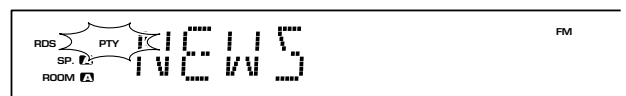
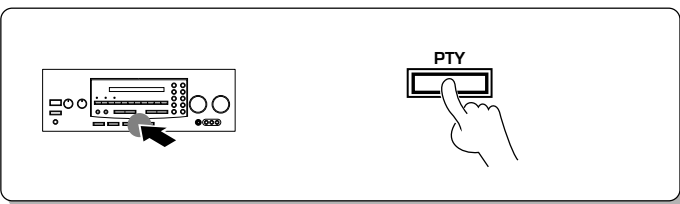

When an RDS broadcast is received, the program type is shown on the display. If no PTY data is available, or if the station is not an RDS station, "NONE" is displayed.

2 Select the program type you desire.

Use the program type table on the right for your convenience.

(A) To select using the TUNING keys

Select while "PTY" is lit.

The TUNING keys let you select from all 29 program types in the order shown at right.

(B) To select with the numeric keys

The numeric keys allow you to select programme types 1 to 0 directly. If you want to select one of the other programme types, use the TUNING key.

Program type table

(A)	(B)	Program Type Name	Display
(V) DOWN ↑ (^) UP	1	Pop Music	POP M
	2	Rock Music	ROCK M
	3	* M.O.R. Music	M.O.R. M
	4	Light Classic Music	LIGHT M
	5	Serious Classic Music	CLASSICS
	6	Other Music	OTHER M
		Weather	WEATHER
		Finance	FINANCE
		Children's programmes	CHILDREN
		Social Affairs	Social A
		Religion	RELIGION
		Phone in	PHONE IN
		Travel	TRAVEL
		Leisure	LEISURE
		Jazz Music	JAZZ
		Country Music	COUNTRY
		Oldies Music	OLDIES
		Folk Music	FOLK M
		Documentary	DOCUMENT
		7 News	NEWS
		8 Current Affairs	AFFAIRS
		9 Information	INFO
		0 Sport	SPORT
		Education	EDUCATE
		Drama	DRAMA
		Cultures	CULTURE
		Science	SCIENCE
		Varied Speech	VARIED
		*M.O.R. Music (Middle of the Road Music)	

"NO DATA" is displayed if this operation is attempted before performing the RDS Auto Memory operation.

• The operations shown in (A) can also be performed with the P.CALL keys on the remote control.

Operations

3 Start the search.

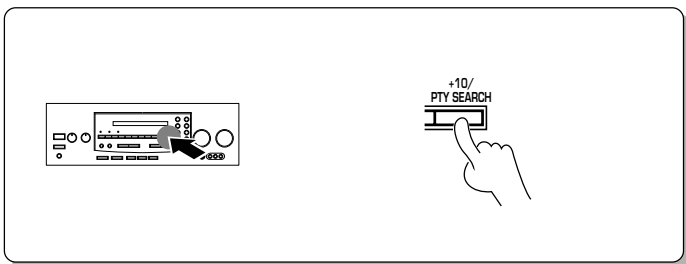

To select another program type
Repeat steps 1, 2 and 3

EXAMPLE: Searching for a Rock Music broadcast.

Display while searching

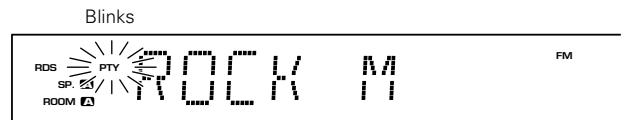

Program type name display

Display when a station is received.

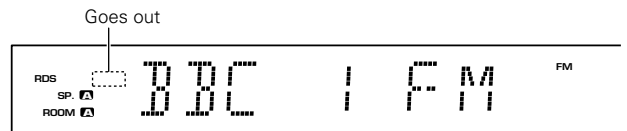

Station name display

- No sound is heard while "PTY" is blinking.
- If the desired program type cannot be found, "NO PROG" is displayed, then after several seconds the display returns to the original display.
- If the desired program type is found, that program is received. The program type display changes temporarily to the frequency display, and then to the station name display.

3 2 When the receiver is tuned to an RDS EON station (a station at which the EON indicator lights up), this function lets you set the receiver to automatically switch stations to receive news, traffic, or information programs as they are broadcast. When the broadcast is over, the receiver returns to the original station automatically.

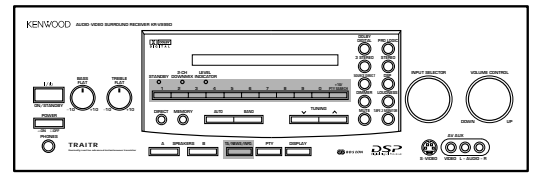
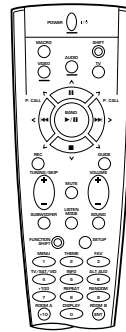

Preparation

- Set the broadcast band to FM.

Keys or controls used in this operation.

Reserving the desired information

1 Complete steps 1~3 of "Presetting RDS stations (RDS AUTO MEMORY)".



2 Select the information you desire.

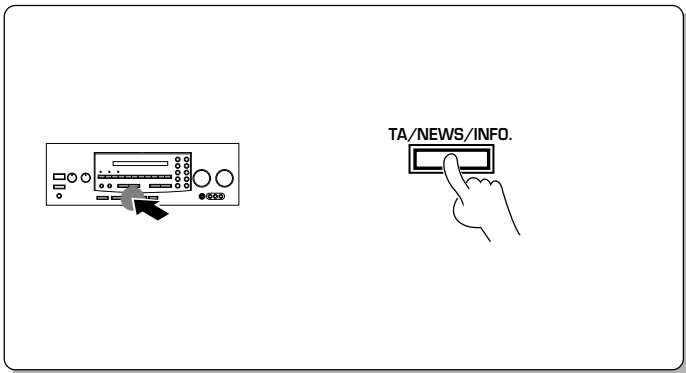

Note Skip this step if you have already completed the RDS AUTO MEMORY procedure.

- The EON function will not work if all 40 FM preset stations were stored manually using the procedure shown in "Presetting radio stations manually". Be sure to use the RDS automatic memory function.

Display When "TA" is selected

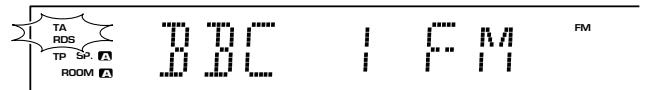

"TP" lights for stations where TP (Traffic Program) information can be received.

Each press switches the reservation mode as follows:

- ① **TA** (Traffic Announcement)
- ② **NEWS** (News)
- ③ **INFO.** (Information)
- ④ off (**EON** off)

- If "TA", "NEWS" and "INFO" can not be selected, carry out the RDS automatic memory function again. → 28

3 Tune to a preset RDS station.

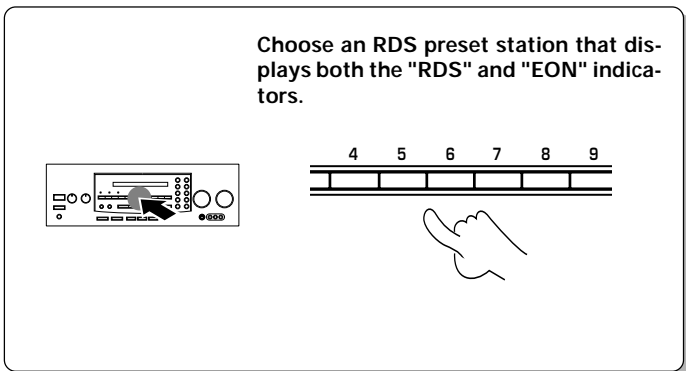

Press the numeric keys in the following order:

For "15", press **+10**, **5**

For "20", press **+10**, **+10**, **0**

- If you make a mistake entering a two digit number, press the **+10** key several times to return to the original display and start again.

Display When "TA" is selected

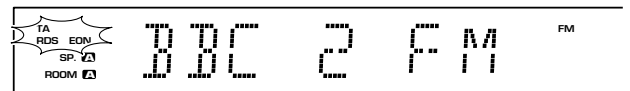

Be sure "EON" appears in the display

- If you want to reserve **TA**, receive a station with which the **TP** indicator lights.
- When "**EON**" does not light although an RDS station is received, that station is not transmitting EON data. Please select a different station.

4 Wait for the information you selected while listening to the current station.

The receiver will wait for the desired information to start as long as the tuner is set to a preset RDS station that displays both the "EON" and "RDS" indicators, and the power is turned ON.

When listening to the tuner:

Be sure to stay tuned to stations that display both the "EON" and "RDS" indicators.

To listen sources other than the tuner:

- ① Tune in a station which that displays both the "EON" and "RDS" indicators, then use the **INPUT SELECTOR** to switch the input to the source you desire.
- ② Even when the **INPUT SELECTOR** is set to a source other than tuner, it will automatically switch to tuner when the desired EON program starts to broadcast. During this period, the source selected in step ① continues playing, but will not be heard.
- ③ When reception of the desired EON program is complete, the **INPUT SELECTOR** returns to the previous input source.

- When the power is OFF, the EON function does not operate.
- If a reserved EON program starts to broadcast during analog recording, the **INPUT SELECTOR** switches to the tuner and the station broadcasting the EON program is recorded.

When waiting for information while listening to a RDS station without the EON function

If the "EON" indicator does not light in steps 3 and 4 and the desired kind of information has already been selected, the information from only the station being received will be waited for.

TP (Traffic Program) indication

When the "TP" indicator is lit, this means that the presently-received station or a station in the same network is transmitting traffic information. When "TP" is displayed for the station being received, the traffic information of this station can be received without EON reservation.

To cancel EON reservation

Turn the "TA", "NEWS" and "INFO." indicators off.



Each press switches the reservation mode as follows:

- ① **TA** (Traffic Announcement)
- ② **NEWS** (News)
- ③ **INFO.** (Information)
- ④ off (**EON** off)

Should be off

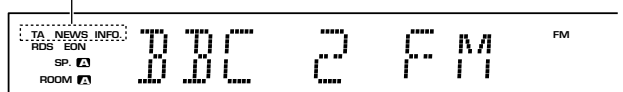

This receiver incorporates 4 different sound modes to let you enjoy surround sound with a wide variety of program sources. The Dolby Digital (AC-3) and Dolby Pro Logic surround sound let you enjoy theater-like surround effects when you play Dolby Digital (AC-3) and Dolby Pro Logic program sources (like Laserdiscs and DVDs). Dolby 3 Stereo creates a panoramic frontal sound field while keeping dialog on screen. The Digital Signal Processing (DSP) modes let you create a variety of different sonic environments from almost any type of program source.

To obtain the best possible surround sound, be sure to complete "Surround set up" before using the surround modes. → 18

Sound modes

Dolby Digital (AC-3)

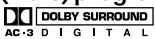
The Dolby Digital (AC-3) surround format lets you enjoy up to 5.1 channels of digital surround sound from Dolby digital (AC-3) program sources (such as Laserdisc software marked ). Compared with previous Dolby surround, Dolby Digital (AC-3) provides even better sound quality, greater spatial accuracy, and improved dynamic range. Some Dolby Digital (AC-3) programs carry information that lets you compress the dynamic range of the sound track, without degrading the sound quality, for softer sound effects when you listen late at night ("Midnight mode").

→ 37

Note

Although a full set of speakers (front left, right, and center, rear left and right, and a subwoofer) is required for true 5.1 channel Dolby Digital (AC-3) surround sound, this receiver lets you enjoy Dolby Digital (AC-3) (and Dolby Pro Logic) program sources, even if you connect only the front speakers. ("Surround set up") → 18

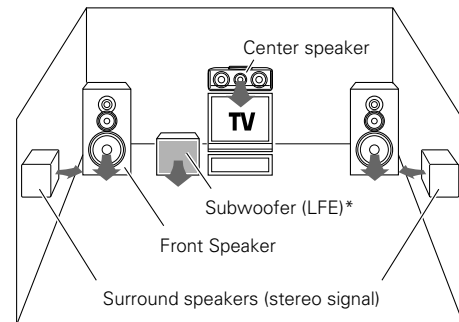

* LFE = Low Frequency Effects. This channel delivers separate non-directional bass signals to the subwoofer for more dynamic deep bass sound effects.

Although only Dolby Digital (AC-3) soundtracks incorporate a separate low frequency channel, connecting a subwoofer will also improve deep bass performance in the other surround modes.

Dolby Pro Logic

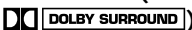
Dolby Pro Logic is a specially encoded 2 channel surround format designed to provide theater-like surround sound from Dolby Pro Logic program sources (such as video and Laserdisc software marked ). This receiver is equipped with a Dolby Pro Logic surround decoder to let you enjoy the wide variety of currently available Dolby Pro Logic home video software.

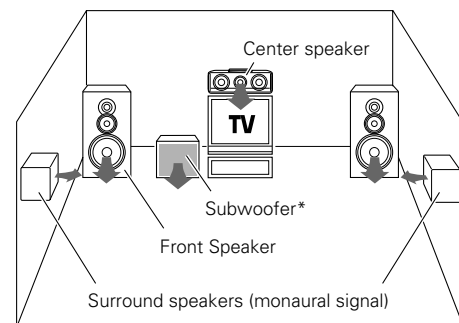

* Optional in this mode.

Dolby 3 Stereo

Dolby 3 Stereo creates a panoramic frontal sound field while maintaining the dialog in an on-screen position. This mode is designed for use with Dolby program sources, but can also improve sound field unity for non-Dolby program sources. Dialog positioning and sound image definition, however, may not be as accurate when used with non-Dolby program sources.

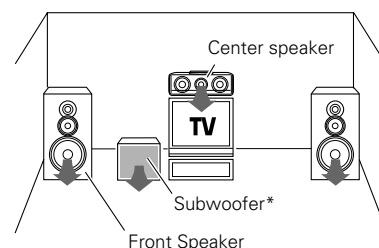



* Optional in this mode.

DSP mode

The DSP mode lets you add the atmosphere of an arena, jazz club, or stadium to almost any type of program source.* These modes are particularly effective when used with stereo program sources, like CD, television, and FM radio. You might enjoy trying the STADIUM or ARENA mode the next time you watch a concert or sporting event!

The WALL parameter lets you adjust the "brightness" of the sonic environment according to your preference. →  37

The ROOM SIZE parameter lets you adjust the size of the sonic environment according to your preference. →  37

The EFFECT level lets you adjust the "presence" of the sonic environment according to your preference. →  37

* The DSP mode will produce a stereo-like surround effect from monaural sources, but there will be some reduction in the presence of the arena, jazz club, or stadium (etc.).

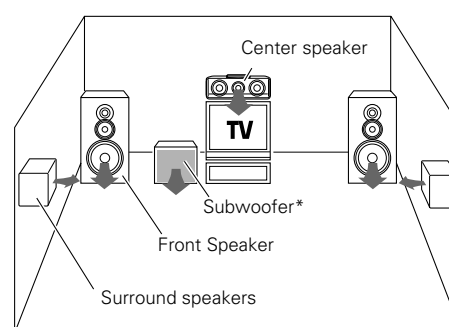

* Optional in this mode.



What's DSP?

DSP stands for Digital Signal Processor.

The way a sound is heard in an actual environment depends on a variety of different factors. One of the most important is reverberation (the act of decaying elements of sound echoing in various places).

The DSP modes produce the feeling of presence by using the DSP to create reverberation, without spoiling the sound quality of the original signal.

Manufactured under licence from Dolby Laboratories Licensing Corporation. "Dolby", "AC-3", "Pro Logic" and the double - D symbol are trademarks of Dolby Laboratories Licensing Corporation.

DOLBY AC-3 can be used when playing DVD or LD software bearing the  mark and DOLBY DIGITAL (AC-3) format digital broadcasts (etc.). DOLBY PRO LOGIC and DOLBY 3 STEREO can be used when playing video, DVD, or LD software bearing the  mark. DSP modes can be used with any source. Be sure to complete "Surround set up" before using any of these surround modes. → 18

Preparations

- Turn ON related components.
- Complete "Surround set up". → 18
- Set the **INPUT SELECTOR** to the component you wish to play back with surround sound.

Surround Play

1 Select the SOUND menu.

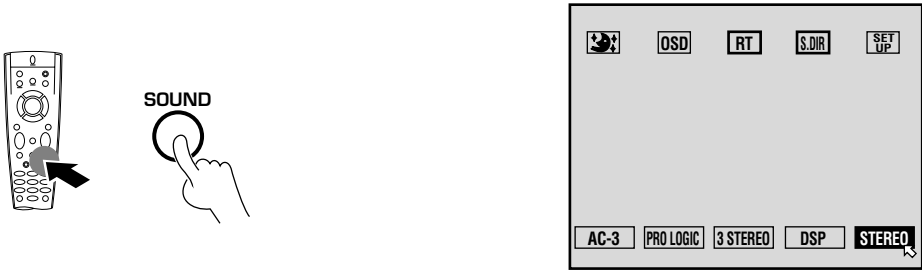

2 Select a surround mode.

Select the icon for the mode you desire. The selected icon turns blue. The surround mode settings are stored separately for each input. Surround modes can also be selected by using the **LISTEN MODE** key on the remote control.

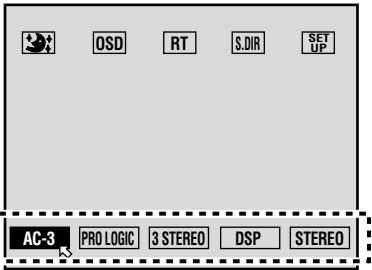

Midnight mode → 37
 Source direct °
 Displays set up menu °
 OSD °
 Radio Text °

DOLBY DIGITAL (AC-3)
 When a Dolby Digital (AC-3) format signal is input, press to select the Dolby Digital (AC-3) mode. To select this icon, the input selector must be set to VIDEO 2, 3, or 4. No sound will be heard if selected when normal stereo sources are input.

DOLBY (PRO LOGIC)
 Selects the DOLBY PRO LOGIC mode. To select this icon, the surround speakers must be selected. → 18

DOLBY (3 STEREO)
 Selects the DOLBY 3 STEREO mode. To select this icon, the center speaker must be selected. → 18

DSP
 Turns on the current DSP mode and switches to the DSP screen where you can adjust various aspects of each DSP mode.

STEREO
 Cancels surround playback. If selected when a Dolby Digital AC-3 signal is input, the 2 CH DOWNMIX indicator on the front panel lights up and the signals are downmixed to 2 channel stereo.

Source Direct (S.DIR)
 Lets you pass the source material direct to the amplifier, bypassing any audio processing.

3 Press the SOUND key on the remote to turn off the on-screen display, then press either VIDEO, AUDIO, or TV key on the remote to cancel the OSD remote control mode.

4 Start playing the video software.

5 Adjust the volume.

 To enjoy Dolby Digital (AC-3) surround (as well as all the other surround modes) from a single component, be sure to use a Dolby Digital (AC-3) compatible source component. Connect the Dolby Digital (AC-3) compatible source component's AC-3 format digital audio signal to one of the DIGITAL INPUT jacks on the back of the receiver. Connect the normal audio signal correctly to the respective component's AUDIO jacks. → 10 → 11

To select a DSP mode

① Press the DSP icon.

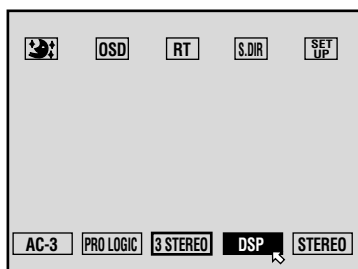

② Select a DSP mode

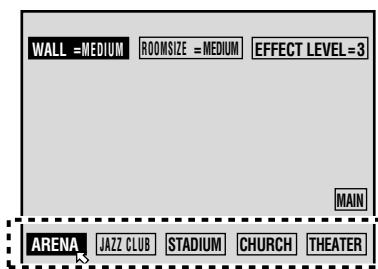

ARENA : Simulates the presence of an indoor concert arena.

JAZZ CLUB : Simulates the presence of a jazz club.

STADIUM : Simulates the presence of an outdoor stadium.

CHURCH : Simulates the presence of a church with high ceilings.

THEATER : Simulates the presence of a movie theater.

To adjust the DSP modes

Adjusting the WALL type, ROOM SIZE, and EFFECT LEVEL lets you create different types of surround effects.

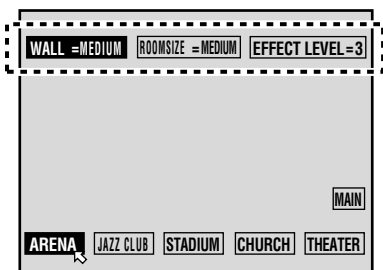

① Select a parameter .

- WALL : Lets you choose from 3 different wall types(SOFT, MEDIUM, HARD).
- ROOM SIZE : Lets you choose from 3 different room sizes (SMALL, MEDIUM, LARGE).
- EFFECT LEVEL : Lets you choose from 5 different effect levels (1, 2, 3, 4, 5).

② Adjust the parameter using the TUNING/SKIP keys on the remote control.

③ Press MAIN to return to the main sound menu or press the SOUND key on the remote to turn off the on-screen display.

④ Press either VIDEO, AUDIO, or TV key on the remote to cancel the OSD remote control mode.

Convenient functions

Midnight mode (Dolby Digital (AC-3) mode only)

When watching movies at night you might not be able to raise the volume as loud as normal. Midnight mode compresses the dynamic range of previously specified parts of the AC-3 sound track (like scenes with sudden increases in volume) to minimize the difference in volume between the specified and non-specified parts. This makes it easy to hear all of the sound track, even when listening at low volumes.

① Select the midnight mode icon.

② Adjust the parameter using the TUNING/SKIP keys on the remote control.



- Some Dolby Digital (AC-3) software may not be compatible with the Midnight mode.
- Midnight mode has no effect on parts of the sound track that are not specified for compression.

Display dimmer adjustent

The DIMMER key on the front panel lets you select the brightness of the receiver's display. You might find this useful if you darken your room to watch movies or listen to music.

When the remote control is set to operate a video component, the FUNCTION SHIFT and DISPLAY key combination can also be used to change the display on the respective video component.

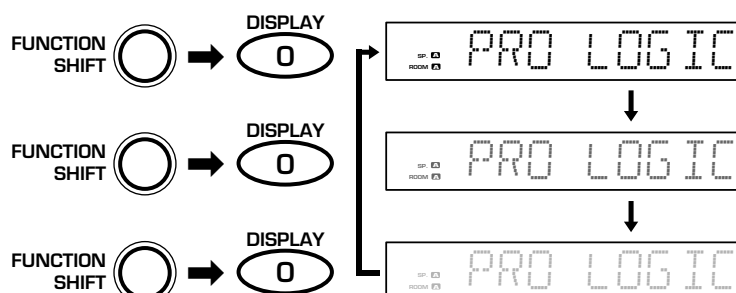

OSD switch

When recording programs or watching movies you may want to turn of the OSD display mode. When the OSD display mode is ON, each operation of the remote control is displayed on the monitor TV. When OSD display mode is OFF, the receiver will only shows the on-screen display when the SOUND or SETUP keys are pressed.

Press to switch.



SOURCE DIRECT switch

Lets you pass the source material direct to the amplifier, bypassing any audio processing. When SOURCE DIRECT is ON, surround sound is turned off and the tone controls are bypassed.

Press to switch.



SET UP switch

Lets you access the SET UP screen if necessary. See "Surround setup" for details regarding the SET UP screen. [→ \[18\]](#)

Press to access the SET UP screen.



RADIO TEXT switch

Lets you display radio text messages transmitted from the currently tuned FM RDS station on the screen of your monitor TV (even if the input selector is set to a different input). When RT is set to ON and a radio text broadcast is received, the radio text scrolls across the bottom of the monitor. [→ \[27\]](#)

Press to switch.



LISTEN MODE key

The LISTEN MODE key on the remote control lets you switch the sound mode directly from the remote control.



Press to switch.

- ① STEREO
- ② AC-3
- ③ PRO LOGIC
- ④ 3 STEREO
- ⑤ ARENA
- ⑥ JAZZ CLUB
- ⑦ STADIUM
- ⑧ CHURCH
- ⑨ THEATER

SUBWOOFER adjustment

The SUBWOOFER key on the remote control lets you adjust the output level of the subwoofer while listening to a favorite source. First press the SUBWOOFER key to select the subwoofer operation mode, then use the VOLUME key to adjust the output level.

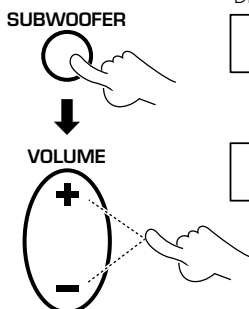

Display when SUBWOOFER is pressed.

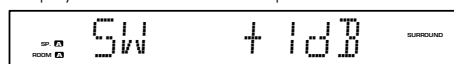

The displayed value changes.

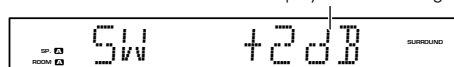

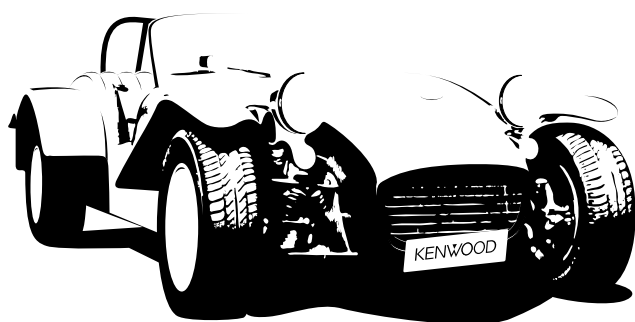

Getting the most from your remote control

The remote control supplied with this receiver is also capable of controlling components from a variety of manufacturers once you register the appropriate setup codes into the remote control unit.

Refer to "Remote operation of other components" for details about the operations available for each component. → 60

* When registering setup codes for KENWOOD audio components which are connected to this unit by system control cords, use the following codes to insure proper system control operation: Cassette: 7000, CD: 8099, MD: 9000. → 12

To control other KENWOOD components (VCRs, LD players, audio components not connected with system control cords, etc.) follow the procedure described below.

Low battery warning

Replace all four batteries with new ones when you notice a shortening of the distance from which the remote control will operate or if the remote control blinks 5 times when you push a key. The remote control is designed to retain set up codes in memory while you change batteries.

Registering setup codes for other components

1 Find the setup code of the component to be registered.

- Refer to the setup code lists to find the setup code for the component to be registered. → 52
Example: To register a CD made by KENWOOD, you would enter "8037"
- If you purchase a new component that is not covered by the setup code list, you can use the FutureSet upgrade feature. → 49

2 Hold down the ENT key until the backlight flashes twice and remains lit.

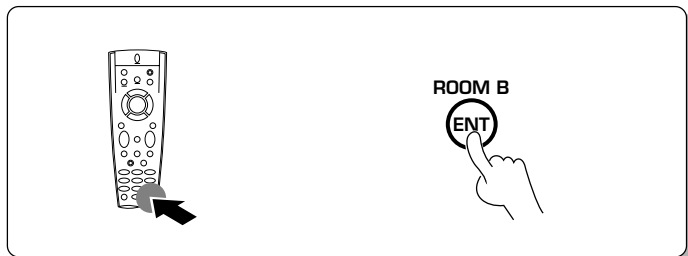

3 Select the component to be registered.

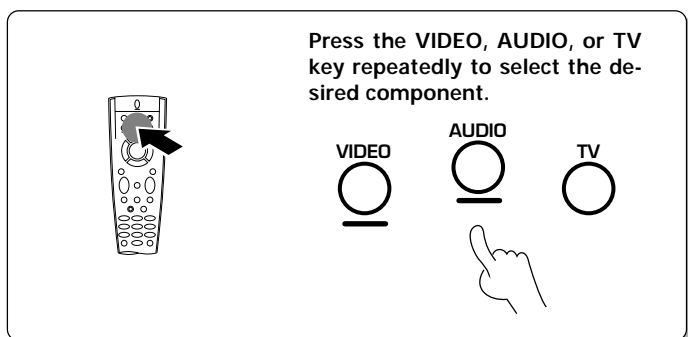

Input	Component	Maker	Code	Key
(CD)	CD player	KENWOOD	8028, 8037	AUDIO
VIDEO 1				
VIDEO 2				
VIDEO 3				
VIDEO 4				
TAPE1/MD				
CD				
PHONO				
—	TV 1			
—	TV 2			
—	CABLE			

- At this time all inputs become available regardless of any earlier registration.



Perform each of the following steps within 5 seconds.

VIDEO key

- 1 VIDEO1 (SAT)
- 2 VIDEO2 (LD)
- 3 VIDEO3 (VCR)
- 4 VIDEO4 (DSS)

AUDIO key

- 1 CD (CD)
- 2 TAPE1/MD (TAPE)
- 3 PHONO

TV key

- 1 TV1
- 2 TV2
- 3 CABLE

- Example : To register the component connected to the VIDEO 1 jacks, select "VIDEO 1 (SAT)".

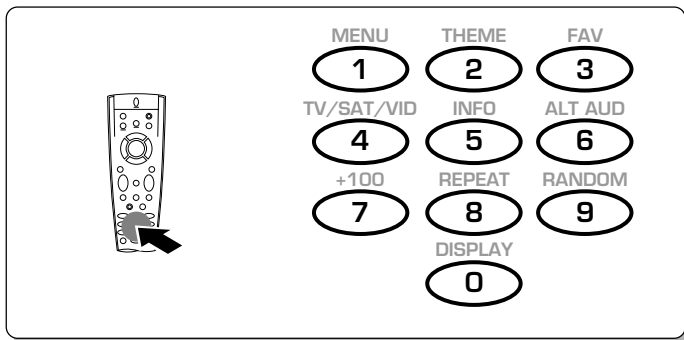

4 Enter the setup code.

- Example: Press 5258 to register a LD player made by KENWOOD.
- The backlight flashes once each time a number is entered.
- If an invalid setup code is entered the remote will output one long blink, disregard that code and return to the beginning of step 4.
- If you push an invalid key, the remote will exit the setup mode.

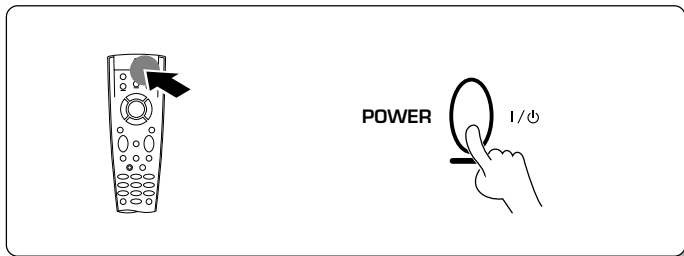
5 Press **POWER**, and check to see that the component you want to control turns on.

- **PLAY** or **TUNING/SKIP (+/-)** can also be used instead of **POWER**.
- If the component does not react, and there is more than one setup code, enter another setup code and try again.
- If the component is already on, pressing **POWER** will turn it off.

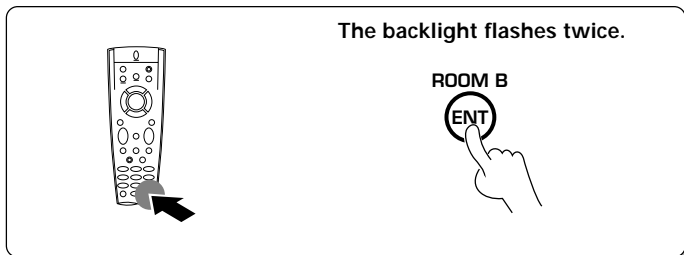
6 Press the **ENT** key to store the code you have just input.

- This code replaces any previous setup codes entered for the respective component.

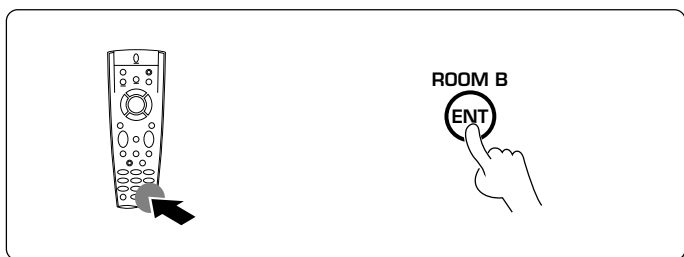
7 Repeat steps 3 through 6 to register additional components until all components have been registered.**8** Once setup codes have been entered for all components, hold down the **ENT** key until the backlight flashes twice.

- If you have components that are not remote controllable, like a record player (etc.), you will need to register a Non-IR code at the respective input. This keeps the respective input in the remote control's cyclic list so you can select it using the remote control. Please consult the owner's manual of the components you are connecting for information regarding remote controllability. The list of Non-IR codes is included at the beginning of the Set up code chart. → 51

- This operation should take about 3 seconds.
- Once registered, the display on the receiver shows the component type instead of the default input name.
Example: if you register a VCR at the VIDEO 1 jacks, "**VCR**" appears instead of "**VIDEO 1(SAT)**".
- Both the default input name and the component type (i.e., "**VIDEO1 'VCR'**") are shown in the on screen display when the OSD mode is set to ON.
- After initial setup, any VIDEO (VIDEO 1, 2, 3, 4) or TV (TV1, TV2, CABLE) inputs that have not been programmed with a setup code or Non-IR code are deleted from the cyclic list (except for the "AV AUX" VIDEO input). The PHONO input will be deleted if a Non-IR code was not registered.
- The **INPUT SELECTOR** on the front panel of the receiver always cycles through all inputs.



Although each setup code is designed to work with a number of different models, certain codes may not work with some models. (Also, certain codes may only operate some of the functions available on a given model.)

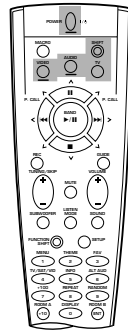

Keys or controls used in this operation.

Operating other components

This operation lets you operate the registered components.

KENWOOD audio components with system control turn on and off automatically with the receiver via the system control connections. → 12

① Use the VIDEO, AUDIO, or TV keys to select the component you desire.

VIDEO AUDIO TV

② Press the SHIFT key and then press the POWER key (within 3 seconds).

SHIFT → ER I/O

③ Press the operation keys you desire.

BAND ▶/||

- Pressing the VIDEO or AUDIO key also changes the input selector on the receiver. If you do not want to change the current input, press the SHIFT key before step ①. → 43

VIDEO key

- ① VIDEO1 (VCR 1)
- ② VIDEO2 (VCR 2)
- ③ VIDEO3 (LD)
- ④ VIDEO4 (DVD)
- ⑤ AV AUX

AUDIO key

- ① CD (CD)
- ② TAPE1/MD (TAPE)
- ③ TUNER
- ④ PHONO

TV key

- ① TV1
- ② TV2
- ③ CABLE

- Pressing the SHIFT key is only required when turning the selected component on or off. Pressing the POWER key directly turns the receiver on and off.

- See "Remote operation of other components" at the end of this manual for a list of keys available with each component. → 60

The remote control mode remains in the set at the component selected in step ① mode until you select another component (etc.).



Be sure to point the remote control at the remote sensor on the receiver when you want to operate KENWOOD components connected by system control cords. Otherwise, point the remote control at the component you want to operate.

This operation lets you change the remote control operation mode without changing the input selector.

You may find this useful when you want to control one component while using another. (For example, if you want to rewind the tape deck while listening to a CD.)

This operation is also useful if you don't know the which mode the remote control is set to. Executing this operation allows you to change or reconfirm the operation mode you desire.

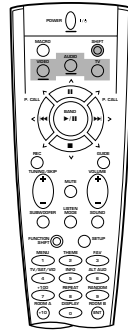

Keys or controls used in this operation.

Changing (confirming) the operation mode

1 Press **SHIFT**.

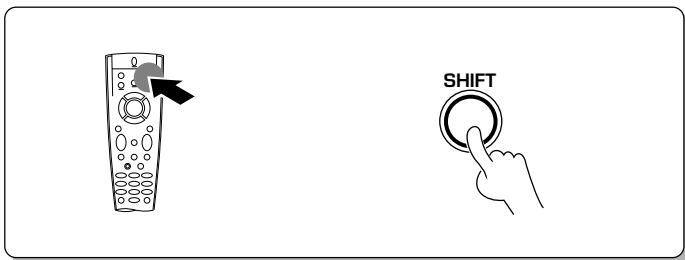

- To operate a TV, start from step 2.



Go to step 2 within 3 seconds.

2 Select the component to be controlled.

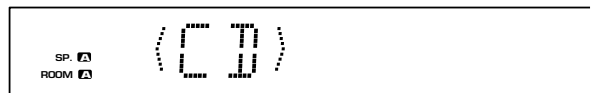
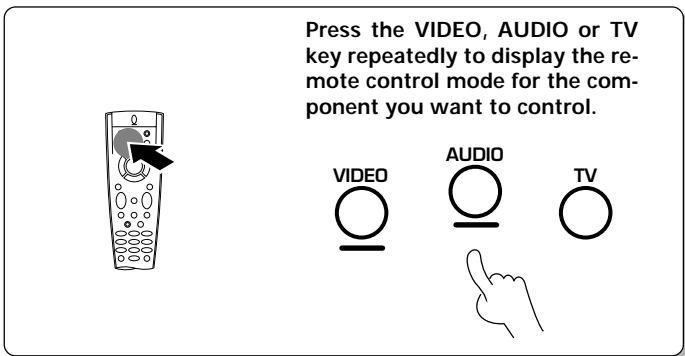

The component to be controlled is displayed in parenthesis

- Pressing any other keys after the **SHIFT** key cancels the shift function and sends the normal code associated with the respective key.
- The input selector does not change during this operation.
- The remote control mode is shown in the on screen display when the OSD mode is set to ON.
- If you press **VIDEO** or **AUDIO** key more than 3 seconds after pressing the **SHIFT** key, the input selector changes together with the operation mode.

3 Execute the desired operations.

- See "Remote operation of other components" for a list of keys available with each component. → 60

The operation mode remains set at the component specified in step 2.

To return control to the original component, press **SHIFT** and then press the **VIDEO** or **AUDIO** key to return to the original control mode.

4 4 The macro play function allows you to set the remote to control several components in succession. After completing this setup, you can perform a series of operations automatically. Enter the setup codes for the components you want to control beforehand.

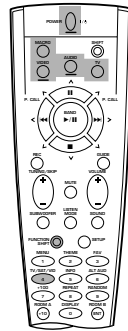

Keys or controls used in this operation.

Preparing for automatic operations (MACRO play)

1 Make a plan of the macro play you want to set up.

The order of the operations may be fairly complex and you may not be able to remember all of the necessary commands during the setup procedure. Use the space provided below to write down the operations in the order you are going to enter them.

①		⑪	
②		⑫	
③		⑬	
④		⑭	
⑤		⑮	
⑥		⑯	
⑦		⑰	
⑧		⑱	
⑨		⑲	
⑩		⑳	

- Up to 20 steps can be memorized for each macro.
- The example below shows the plan for step 4 (which occupies a total of 9 steps) :

1	TV + SHIFT + POWER	3 steps
2	FUNCTION SHIFT + 4	2 steps
3	VIDEO + VIDEO	2 steps
4	SHIFT + POWER	2 steps

Total 9 steps

- If you attempt to store more than 20 steps, the remote will output one long blink and exit the macro programming mode.
- Enter channel numbers (for the monitor TV, etc.) exactly as you would using the original remote.

2 Activate the macro program mode.

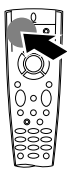

Press and hold the MACRO key until the backlight flashes twice.



Perform each of the following steps within 5 seconds.

3 Select where the macro should be stored.

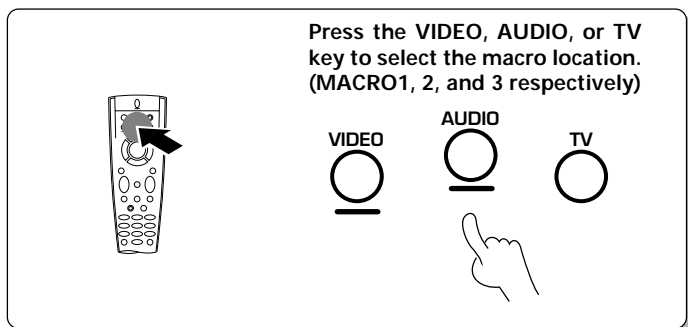

- You can store up to 3 different macros, one at each key: **VIDEO** → "MACRO 1", **AUDIO** → "MACRO 2", **TV** → "MACRO 3"
- The backlight flashes once when you select the macro location.
- Pressing a button other than **VIDEO**, **AUDIO**, or **TV** cancels the macro program mode.

When **VIDEO** is pressed



4 Press the keys to be operated in order.

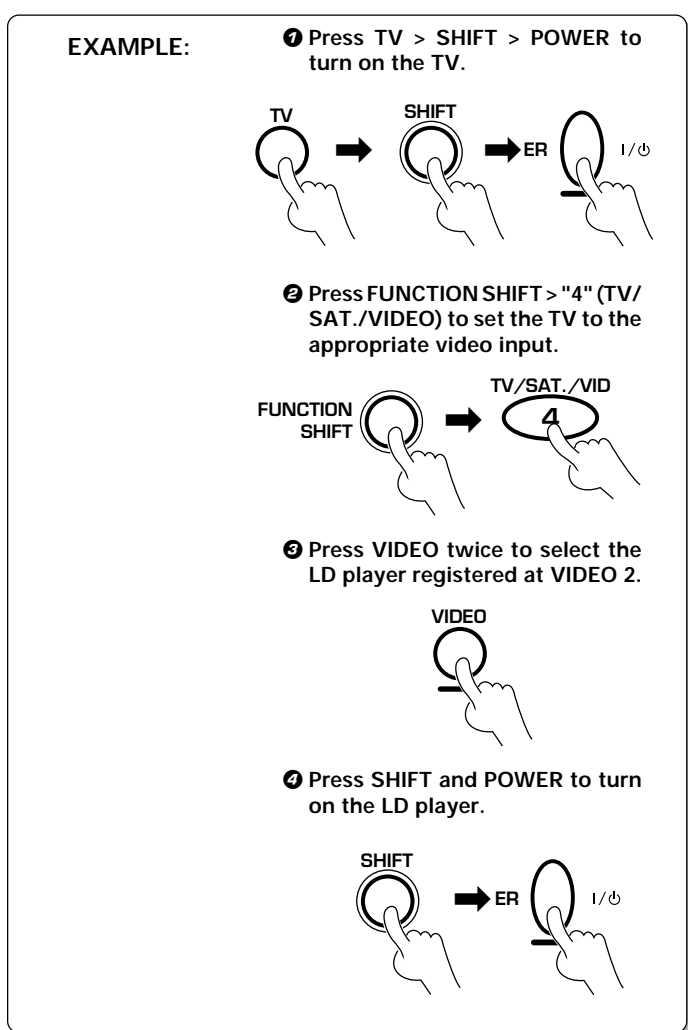

- This example shows you how to create a macro that: turns on the TV, sets the TV to the appropriate input, selects the receiver's input selector to LD, and turns on the LD player. All you have to do is insert the laser disc!
- In order to allow verification of the remote control mode, the name of the selected input appears in the receiver's display when the **VIDEO**, **AUDIO** or **TV** key is pressed. When the **VIDEO** or **AUDIO** key is pressed the receiver's input also changes.

5 Terminate the macro program mode.

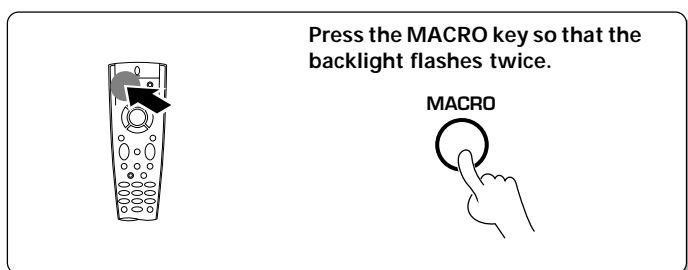

- The macro is stored at the locations specified in step 3. If another macro was previously stored at the same location, it is erased.

Repeat steps 1 through 5 to program up to 3 macros.

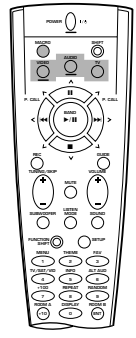

Keys or controls used in this operation.

Executing an automatic operation

1 Press the **MACRO** key.

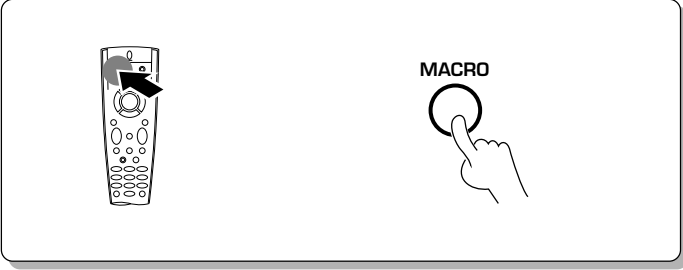

Go to step 2 within 3 seconds.

2 Execute the macro play.

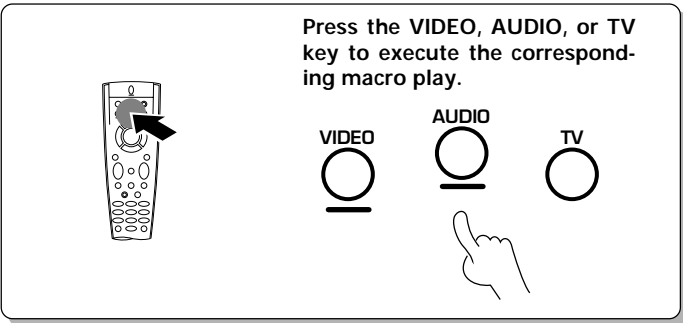

- "MACRO" appears in the front panel and on-screen display and the pre programmed macro is performed:
VIDEO → "MACRO 1", **AUDIO** → "MACRO 2", **TV** → "MACRO 3"
- The remote control flashes once for each command output.
- The remote control will output OSD information to tell you the status of the macro.
- Some devices take up to 1 second to power on. The macro function has an automatic delay after any power function output.
- Pressing a button other than **AUDIO**, **VIDEO**, or **TV** cancels the macro program mode.

When **VIDEO** is pressed



If you make connections to another room, you can use the remote control to select source components and to adjust the volume (etc.) output to the other room. → [15]

*KENWOOD system control operations are only possible when the remote control is set to the Room A operation mode. In order to avoid malfunctions, do not make system control connections to audio components which you plan on controlling with the Room B operations described below.

Only sources connected to the analog AUDIO (L and R) and VIDEO jacks can be output to ROOM B.

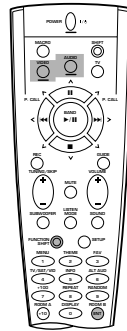

Keys or controls used in this operation.

Controlling the sound in another room (ROOM B)

1 Select a speaker system.

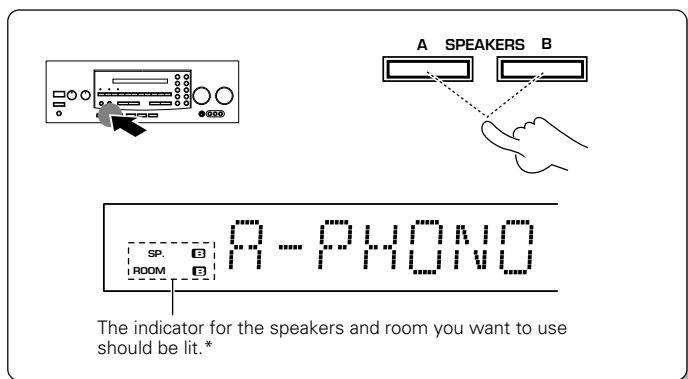

* Audio and video signals are output from the SECOND ROOM PRE OUT jacks regardless of the setting of the SP. A/B and ROOM A/B indicators.

A ON : Select to output sound to ROOM A from the speaker connected to the SPEAKERS A terminals. This setting allows you to enjoy surround playback in ROOM A while outputting sound to ROOM B via the SECOND ROOM PRE OUT jacks.

B ON : Select to output sound to ROOM B via the speakers connected to the SPEAKERS B terminals. Be sure to turn off the subwoofer in ROOM A if one is connected.

A+B ON : Select to output sound to ROOM A from the speakers connected to the SPEAKERS A terminals and output sound to ROOM B from the speakers connected to the SPEAKERS B terminals. ROOM A automatically switches to stereo playback (surround playback is not possible).

A+B OFF : No sound from the speakers. Use this setting when listening with headphones in ROOM A for stereo sound in all playback modes or to listen in ROOM B via the SECOND ROOM PRE OUT jacks.

• The **MUTE** and **VOLUME +/-** keys let you control the sound level in ROOM B.

2 Set the remote control to the ROOM B operation mode.

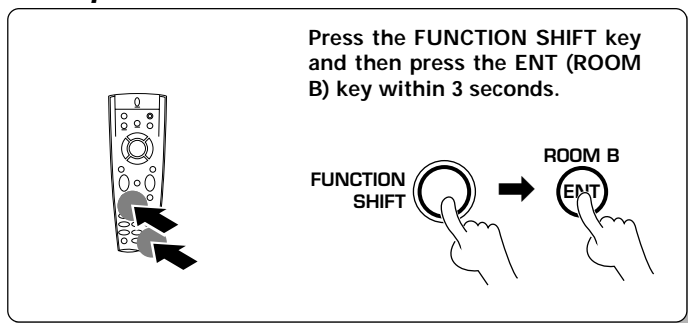

• The **MUTE** and **VOLUME +/-** keys let you control the sound level in ROOM B.

3 Select the desired component.

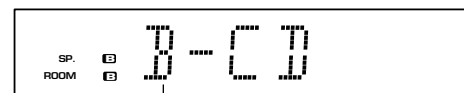
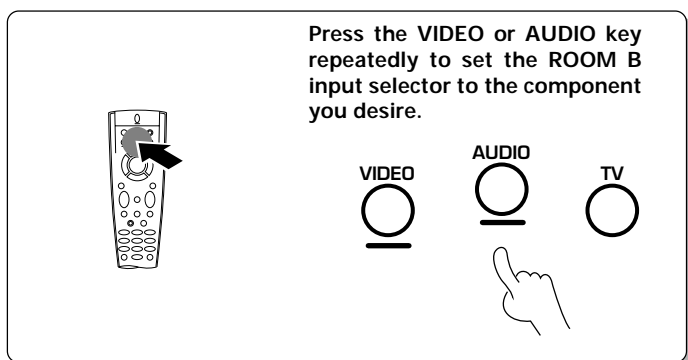

ROOM B input selector

- The setting of the ROOM B input selector also appears in the on screen display.
- The component selected for ROOM B can also be operated using the keys on the remote control. See "Remote operation of other components" for a list of keys available with each component. → [60]

4 Execute the desired operations.

The remote remains in the ROOM B operation mode until you switch back to the ROOM A operation mode.

To return to the ROOM A operation mode, press the **FUNCTION SHIFT** key and then press the **+10 (ROOM A)** key within 3 seconds.

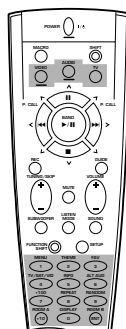

Keys or controls used in this operation.

Setup code correlation

Deleting a setup code

- ❶ Hold down the ENT key until the backlight flashes twice.
- ❷ Select the component to be deleted.
Press the VIDEO, AUDIO, or TV key repeatedly to select the desired component.
- ❸ Enter the 3 digit code "991".
- ❹ Hold down the ENT key until the backlight flashes twice.

- At this time all inputs become available regardless of any earlier registration.

- Example 1 : To delete the registration of the component connected to the VIDEO 1 jacks, select "VIDEO 1".



Perform each step within 5 seconds.

- To resume the factory settings, proceed step 1, then enter "981".

Checking a setup code

- ❶ Hold down the ENT key until the backlight flashes twice.
- ❷ Select the component with setup code you want to check.
Press the VIDEO, AUDIO, or TV key repeatedly to select the desired component.
- ❸ Enter the 3 digit code "990".
- ❹ Press the 1 key and count the number of times the backlight blinks. This is the first number of the 4 digit setup code.
- ❺ Press the 2 key and count the number of times the backlight blinks. This is the second number of the 4 digit setup code.
- ❻ Press the 3 key and count the number of times the backlight blinks. This is the third number of the 4 digit setup code.
- ❼ Press the 4 key and count the number of times the backlight blinks. This is the fourth number of the 4 digit setup code.

- The backlight flashes twice immediately after the "0" is input to confirm input.

- If the backlight does not blink, the first digit in the setup code is 0.

- If the backlight does not blink, the second digit in the setup code is 0.

- If the backlight does not blink, the third digit in the setup code is 0.

- If the backlight does not blink, the fourth digit in the setup code is 0.



Perform each step within 5 seconds.

FutureSet allows you to update the remote control so it can operate new components which do not appear in the setup code list at the end of the manual.

This function allows you to register new setup codes for any or all of the following command positions:

VIDEO1, VIDEO2, VIDEO3, VIDEO4, TV1, TV2, CABLE, CD, TAPE1/MD.

FutureSet codes are stored in memory. Each time a FutureSet upgrade is performed, any previous information in the FutureSet memory location is erased. Please inform your customer service representative if FutureSet has been previously used.

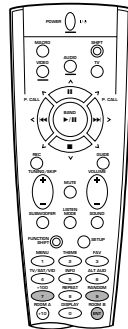

Keys or controls used in this operation.

FutureSet upgrade option (This service will be available until 31 May 1999)

1 Write down the brand name and model number of your component in the space provided before you call.

2 Call our Free-Phone Consumer Help-Line and explain which components you would like to add to your remote control.

UK (including N. Ireland) : 0800-898520

- The free phone upgrade service is not available in countries other than listed above.
- For customers outside the U.K., please contact your Kenwood dealer who will be able to assist you.
- This number is designed specifically for Future Set upgrades, questions about system operation should be first addressed to your place of purchase.

3 Hold down the ENT key until the backlight flashes twice.

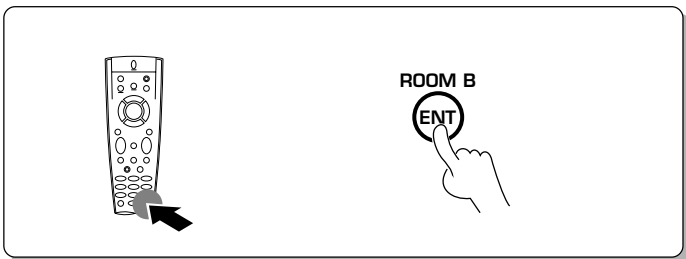

4 Enter the 3 digit code "997".

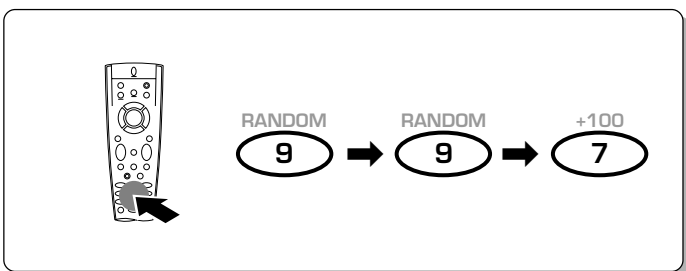

	Type	Brand	Model No.	Remote Model No.
	TV	KENWOOD	KV?-????	RC-????
1				
2				
3				

- After the customer service representative records the brand name and model number of your component, he/she will ask you to hold the remote to the speaker portion of your telephone as shown below. Your remote control is KENWOOD model number: RC-R0905
- The hours for customer service are:
 - Monday-Friday 9:00 am - 7:00 pm (Greenwich time)
 - Saturday 9:00 am - 3:00 pm (Greenwich time)

Complete steps 3 and 4 before holding the remote to the speaker portion of your telephone.

- At this time all inputs become available regardless of any earlier registration.



Go to step 4 within 5 seconds.

- The backlight flashes twice.
- The remote is now in the upgrade mode. The remote will wait for 30 seconds for a valid telephone download signal. If nothing is received within this time, it will revert to normal operation.



Go to step 5 within 30 seconds.

5 0 **5** Hold your remote to the speaker portion of your telephone.

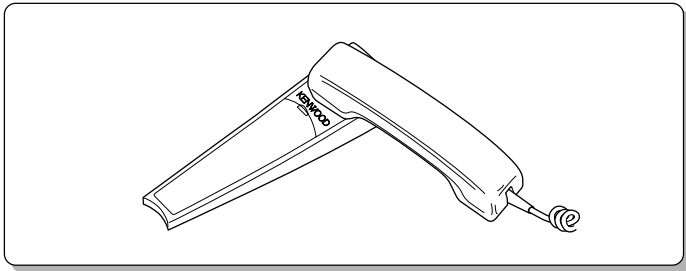

- For each setup code the operator can supply a setup code number. Should you ever need to change your input configuration, this number can be used. Please record for your future reference. If for some reason this information is lost, see "Checking a setup code" in the "Setup code correlation" section for further information.

Code selection after mode download

After successful completion of the download, step 5 above, the remote control automatically enters a special set-up mode which works as described below.

1 Select the component for which you want to register the information downloaded above.

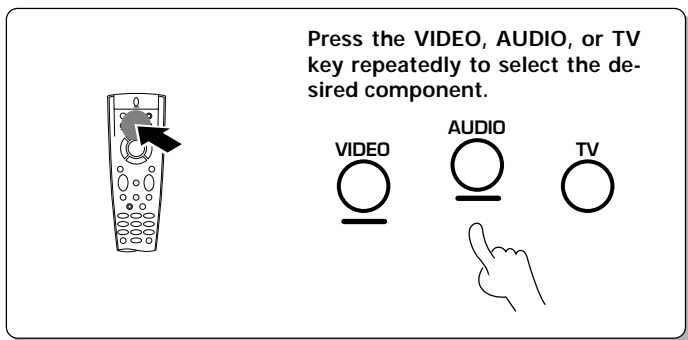

VIDEO key

- ① VIDEO1 (VCR 1)
- ② VIDEO2 (VCR 2)
- ③ VIDEO3 (LD)
- ④ VIDEO4 (DVD)

AUDIO key

- ① CD (CD)
- ② TAPE1/MD (TAPE)
- ③ PHONO

TV key

- ① TV1
- ② TV2
- ③ CABLE

- Example 1 : To register a code at the component connected to the VIDEO 1 jacks, select "VIDEO 1 (VCR)".



Perform each of the following steps within 5 seconds.

2 Press a numeric key.

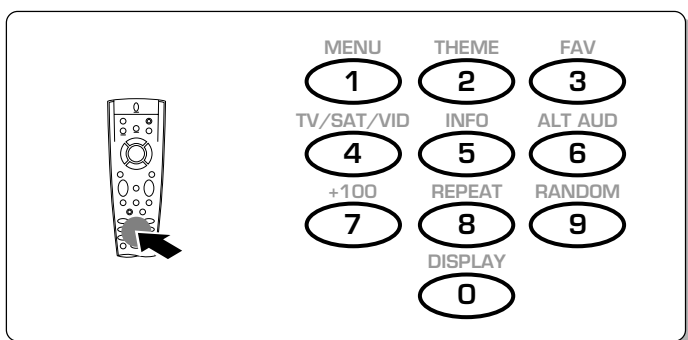

- Press the 1 key to output the POWER code of the first component on your list in step 1 of the previous page. Continue to push buttons 2 through 9 (and 0) until the component you want to register turns on.
- Though the FutureSet memory in your remote control is quite large, only 10 setup POWER codes can be put on the 10 keypad at any one time. If you require a larger download, the standard setup procedure can be used. See "Registering setup codes for other components", your customer service representative can supply you with the downloaded setup code numbers.

3 Repeat steps 1 and 2 to register all of the downloaded information.

4 Hold down the ENT key until the backlight flashes twice.

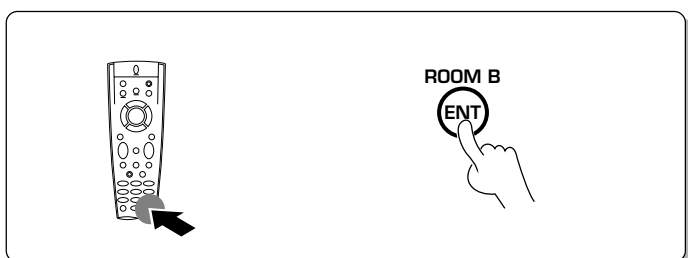

- The setup code for the last POWER code to be sent in step 2 is automatically registered at the location selected in step 1.

- At this time, the remote exits the special set-up mode and returns to its normal operation mode.

Set up code chart

KR-V999D (En/T)

Non-IR codes

CD player	8900
Cassette deck	7900
LD player	5900
Phono	0900

Satellite	2900
TV	1900
VCR	4900

DVD	6900
MD	8900

VCR Set up codes

Maker	Set up codes
Action	4317
Adventura	4000
Aiko	4278
Aiwa	4000, 4307, 4406
Akai	4041, 4315
Akiba	4072
Alba	4278, 4295
American High	4035
Amstrad	4000
Anam	4162, 4240
Anam National	4162, 4454
Anitech	4072
ASA	4037, 4081
Asha	4240
Asuka	4037
Audiovox	4037
Baird	4000, 4041, 4104
Basic Line	4072, 4278
Beaumark	4240
Bell & Howell	4104
Blaupunkt	4034, 4162
Brandt Electronic	4041
Broksonic	4121, 4184, 4211, 4295, 4361
Bush	4072, 4278
Calix	4037
Canon	4035
Carver	4081
CCE	4072, 4278
CGE	4000
Cimline	4072
Citizen	4037, 4278
Colt	4072
Craig	4037, 4047, 4072, 4240
Crown	4072, 4278
Curtis Mathes	4035, 4041, 4060
Cybernex	4240
Daewoo	4045, 4046, 4278
Dansai	4072

Maker	Set up codes
De Graaf	4042
Decca	4000, 4081
Dual	4041
Dumont	4000, 4081, 4104
Dynatech	4000
Elcotech	4072
Electrohome	4037
Electroponic	4037
Emerex	4032
Emerson	4000, 4002, 4037, 4043, 4121, 4184, 4211, 4278, 4295, 4361
ESC	4240, 4278
Ferguson	4041
Fidelity	4000
Finlandia	4081, 4104
Finlux	4000, 4042, 4081, 4104
Firstline	4037, 4043, 4045, 4072
Fisher	4046, 4047, 4066, 4104
Fuji	4033, 4035
Fujitsu	4000
Funai	4000
Garrard	4000
GE	4035, 4060
GEC	4081
Go Video	4232, 4350
GoldHand	4072
Goldstar	4037, 4038
Goodmans	4000, 4037, 4072, 4278
Gradiente	4000
Graetz	4041, 4104, 4240
Granada	4046, 4081, 4104
Grandin	4000, 4037, 4072
Grundig	4034, 4072, 4081
Hanseatic	4037
Harley Davidson	4000

Maker	Set up codes
Harmon/Kardon	4038
Harwood	4072
HCM	4072
Headquarter	4046
HI-Q	4047
Hinari	4072, 4240
Hitachi	4000, 4041, 4042, 4240
Hypson	4072
Imperial	4000
Interfunk	4081
ITT	4041, 4046, 4104, 4240
ITV	4037, 4278
Jensen	4041
JVC	4008, 4041, 4067
Kaisui	4072
KEC	4037, 4278
Kenwood	4038, 4041, 4067
KLH	4072
Kodack	4035, 4037
Korpel	4072
Lenco	4278
Leyco	4072
Lloyd	4000
Loewe	4037, 4081
Logik	4072, 4240
Luxor	4043, 4046, 4048, 4104
LXI	4037
M Electronic	4000
Magnavox	4035, 4039, 4081, 4149
Magnin	4240
Manesth	4045, 4072
Marantz	4035, 4081, 4295
Marta	4037
Matsui	4295
Matsushita	4035, 4162, 4454
MEI	4035

5 2 VCR Set up codes (continued)

Maker	Set up codes
Memorex	4000, 4035, 4037, 4039, 4046, 4047, 4048, 4104, 4240, 4307
Memphis	4072
Metz	4162, 4454
MGA	4043
MGN Technology	4240
Minolta	4042
Mitsubishi	4043, 4067, 4081, 4173
Motorola	4035, 4048
MTC	4000, 4240
Multitech	4000, 4072
Murphy	4000
NAD	4104
NEC	4038, 4041, 4067, 4104
Neckermann	4081
Nesco	4072
Nikko	4037
Nikon	4034
Noblex	4240
Nokia	4041, 4046, 4048, 4104, 4240
Nordmende	4041
Oceanic	4000, 4041
Okano	4315
Olympus	4035
Optimus	4037, 4048, 4104, 4162, 4454
Orion	4121, 4295
Osaki	4000, 4037, 4072
Otto Versand	4081
Palladium	4037, 4041, 4072
Panasonic	4035, 4077, 4162, 4454
Pathe Marconi	4041
Penny	4035, 4037, 4038, 4042, 4240
Pentax	4042
Perdio	4000
Philco	4035, 4038
Philips	4035, 4081
Phonola	4081
Pilot	4037

Maker	Set up codes
Pioneer	4067, 4081
Profitronic	4240
Proline	4000
Protec	4072
Pulsar	4039
Pye	4081
Quarter	4046
Quartz	4046
Quasar	4035, 4077, 4162, 4454
Quelle	4081
Radio Shack	4000, 4037
Radiola	4081
Radix	4037
Randex	4037
RCA	4042, 4060, 4077, 4149, 4225
Realistic	4000, 4035, 4037, 4046, 4047, 4048, 4066, 4104, 4240
Rex	4041
Ricoh	4034
Roadstar	4037, 4072, 4240, 4278
Runco	4039
Saba	4041
Salora	4043, 4046
Samsung	4045, 4240
Sanky	4039, 4048
Sansui	4041, 4067
Sanyo	4046, 4047, 4104, 4240
SBR	4081
Schaub Lorentz	4000, 4041, 4104
Schneider	4000, 4072, 4081
Scott	4043, 4045, 4121, 4184, 4211
Sears	4035, 4037, 4042, 4046, 4047, 4066, 4104
SEG	4240
SEI	4081
Selco	4041
Sharp	4048
Shintom	4072, 4104
Shogun	4240
Siemens	4037, 4081, 4104

Maker	Set up codes
Silva	4037
Singer	4045, 4072
Sinudyne	4081
Sontec	4037
Sony	4032, 4033, 4034, 4035
STS	4042
Sunstar	4000
Suntronic	4000
Sylvania	4000, 4035, 4043, 4081
Symphonic	4000
Tandy	4000, 4104
Tashiko	4000
Tatung	4000, 4041, 4081
Teac	4000, 4041
Technics	4035, 4162
Teknika	4000, 4035, 4037
Teleavia	4041
Telefunken	4041
Tenosal	4072
Tensai	4000
Thomson	4041
Thorn	4041, 4104
TMK	4240
Toshiba	4041, 4043, 4045, 4060, 4066, 4081
Totevision	4037, 4240
Uher	4240
Unitech	4240
Universum	4000, 4037, 4081, 4240
Vector	4045
Vector Research	4038
Victor	4008, 4041, 4067
Video Concepts	4045
Videosonic	4240
Wards	4000, 4035, 4042, 4047, 4048, 4060, 4072, 4149, 4240
XR-1000	4000, 4035, 4072
Yamaha	4038
Yamishi	4072
Yokan	4072
Yoko	4240
Zenith	4033, 4034, 4039

TV Set up codes

Maker	Set up codes
Admiral	1093
Adventura	1046
Aiko	1092
Akai	1030
Alleron	1179
Ambassador	1177
Amstrad	1177
Anam	1180
Anam National	1055, 1250
AOC	1019, 1030, 1137
Audiovox	1180
Belcor	1019
Bell & Howell	1016, 1154
Blue Star	1282
BPL	1282
Bradford	1180
Brockwood	1019
Bush	1282
Candle	1030, 1046, 1056, 1186
Carnivale	1030
Carver	1054
Celebrity	1000
Citizen	1030, 1039, 1046, 1056, 1060, 1092, 1186, 1280
Concerto	1056
Contec	1180
Craig	1180
Crown	1039, 1180
Curtis Mathes	1030, 1039, 1060, 1154
CXC	1180
Daewoo	1019, 1039, 1092, 1154, 1451
Daytron	1019
Dumont	1017, 1019
Electroband	1000
Electrohome	1381
Emerson	1019, 1039, 1154, 1177, 1178, 1179, 1180, 1236, 1280, 1282, 1463
Envision	1030
Finlux	1179
Fisher	1154, 1159
Fortress	1093
Fujitsu	1179
Funai	1179, 1180
Futurtech	1180

Maker	Set up codes
GE	1021, 1027, 1047, 1051, 1055, 1135, 1178, 1282, 1451
General	1186
Gibraltar	1017, 1019, 1030
Goldstar	1019, 1030, 1039, 1056, 1178
Goodmans	1179
Grandin	1282
Grunpy	1179, 1180
Hallmark	1178
Harvard	1180
HCM	1282
Hinari	1179
Hisawa	1282
Hitachi	1056, 1145, 1151
Hypson	1282
Infinity	1054
Janeil	1046
JBL	1054
JCB	1000
JVC	1053
Kaisui	1282
KEC	1180
Kenwood	1019, 1030
Kloss	1024, 1046
KTV	1030, 1039, 1180, 1280
Logik	1016
Luxman	1056
LXI	1047, 1054, 1154, 1156, 1178
Magnavox	1024, 1030, 1054, 1186, 1187
Majestic	1016
Marantz	1030, 1054
Matsui	1177
Matsushita	1250
Megatron	1145, 1178
Memorex	1016, 1056, 1150, 1154, 1178
MGA	1019, 1030, 1150, 1178
Midland	1017, 1039, 1047, 1051, 1135
Minutz	1021
Mitsubishi	1019, 1150, 1178
Motorola	1055, 1093
MTC	1019, 1030, 1056, 1060
Multitech	1180
NAD	1156, 1166, 1178

Maker	Set up codes
NEC	1019, 1030, 1056
Nesco	1179
Nikko	1030, 1092, 1178
Noshi	1018
NTC	1092
Onwa	1180
Optimus	1154, 1166, 1250
Optonica	1093, 1165
Orion	1177, 1236
Panasonic	1051, 1055, 1250
Penny	1018, 1019, 1021, 1027, 1030, 1039, 1047, 1051, 1060, 1135, 1156, 1178
Philco	1019, 1030, 1054
Philips	1054
Pilot	1019, 1030, 1039
Pioneer	1166
Portland	1019, 1039, 1092
Prism	1051
Proscan	1047
Proton	1031, 1178, 1466
Pulsar	1017, 1019
Quasar	1051, 1055, 1165, 1250
Radio Shack	1019, 1030, 1039, 1047, 1056, 1154, 1165, 1178, 1180
RCA	1018, 1019, 1047, 1090, 1135
Realistic	1019, 1030, 1039, 1056, 1154, 1165, 1178, 1180
Runco	1017, 1030
Saisho	1177
Sampo	1030, 1039
Samsung	1019, 1030, 1039, 1056, 1060, 1178, 1427
Samsux	1039
Sanyo	1154, 1159
Scimitsu	1019
Scotch	1178
Scott	1019, 1178, 1179, 1180, 1236
Sears	1047, 1054, 1056, 1154, 1156, 1159, 1178, 1179
SEI	1177
Sharp	1039, 1093, 1165
Shogun	1019
Signature	1016
Simpson	1186, 1187

5 4 TV Set up codes (continued)

Maker	Set up codes
Sinudyne	1177
Sony	1000
Soundesign	1178, 1179, 1180, 1186
Spectricon	1137
SSS	1019, 1180
Starlite	1180
Supra	1056
Supre-Macy	1046
Supreme	1000
Sylvania	1030, 1054, 1381
Tandy	1039, 1093

Maker	Set up codes
Tatung	1055
Technics	1051, 1250
Technol Ace	1179
Techwood	1051, 1056
Teknika	1016, 1019, 1039, 1054, 1056, 1060, 1092, 1150, 1179, 1180, 1186, 1312
Tera	1031
TMK	1056, 1177, 1178
Tomashi	1282
Toshiba	1060, 1154, 1156
Totevision	1039

Maker	Set up codes
Triumph	1177
Universal	1027
Vector Research	1030
Victor	1053, 1250
Vidikron	1054
Vidtech	1019, 1178
Viking	1046, 1312
Wards	1016, 1019, 1021, 1027, 1030, 1054, 1056, 1165, 1178, 1179
Yamaha	1019, 1030
Zenith	1016, 1017

Satellite Set up codes

Maker	Set up codes
Echostar	2280
General Instrument	2361

Maker	Set up codes
Jerrold	2361
Primestar	2361

Maker	Set up codes
Realistic	2052
Uniden	2052

LD player Set up codes

Maker	Set up codes
Carver	5194
Disco Vision	5023
Hitachi	5023
Kenwood	5258
Magnavox	5194
Marantz	5194

Maker	Set up codes
Mitsubishi	5059
NAD	5059
Panasonic	5204
Philips	5194
Pioneer	5023, 5059

Maker	Set up codes
Quasar	5204
Sega	5023
Sony	5201
Telefunken	5059
Theta Digital	5194

DSS Set up codes

Maker	Set up codes
Alphastar	3772
Echostar	3775
HTS	3775
Hughes Network Systems	3749

Maker	Set up codes
Jerrold	3627
Panasonic	3701
Primestar	3627

Maker	Set up codes
RCA	3566
Sony	3639
Toshiba	3790

DVD Set up codes

Maker	Set up codes
Panasonic	6490
Toshiba	6503

Cable Set up codes

Maker	Set up codes
ABC	0001, 0003, 0007, 0008, 0011, 0013, 0014, 0017
Antronix	0022
Archer	0022, 0153, 0797
Belcor	0056
Cable Star	0056
Cabletenna	0022
Cableview	0022
Century	0153
Citizen	0153
Colour Voice	0025
Comtronics	0040
Contec	0019
Daeryung	0008
Eastern	0002
Everquest	0015, 0040
Garrard	0153
GC Electronics	0056
Gemini	0015
General Instrument	0011, 0276, 0476
GoldStar	0040, 0144
Hamlin	0009, 0020, 0034, 0259

Maker	Set up codes
Hitachi	0011
Hytex	0007
Jasco	0153
Jerrold	0003, 0011, 0012, 0014, 0015, 0276, 0476
Memorex	0000
Movie Time	0063, 0156
NSC	0063, 0156
Oak	0007, 0019
Panasonic	0000, 0021, 0107
Paragon	0000
Philips	0025, 0153
Pioneer	0144, 0753
Prelude	0770
Pulsar	0000
PVP Stereo Visual Matrix	0003
Radio Shack	0797
RCA	0021
Regal	0020, 0259
Regency	0002
Rembrandt	0011
Runco	0000
Samsung	0040, 0144

Maker	Set up codes
Scientific Atlanta	0008, 0017, 0477
Signal	0015, 0040
Signature	0011
SL Marx	0040
Sprucer	0021
Starcom	0003, 0015
Stargate	0015, 0040, 0770
Starquest	0015
STS	0156
Sylvania	0001
Tandy	0258
Televue	0040
Texscan	0001
Tocom	0012, 0013
Toshiba	0000
Tusa	0015
TV86	0063
Unika	0022, 0153
United Artists	0007
United Cable	0003
Universal	0022, 0056, 0153
Viewstar	0063, 0258
Zenith	0000, 0525

CD Player Set up codes

Maker	Set up codes
Aiwa	8124, 8157
Arcam	8157
AudioTon	8157
California Audio Lab	8029
Carver	8157, 8179
Cyrus	8157
Denon	8003
DKK	8000
Dynamic Bass	8179
Elektra	8393
Emerson	8305
Fisher	8048, 8088, 8179
Garrard	8393
Genexxa	8032, 8305
Goodmans	8305
Grundig	8157
Hitachi	8032
JVC	8072, 8655
Kenwood	8028, 8037, 8048, 8099, 8190, 8858, 8859

Maker	Set up codes
Krell	8157
Linn	8157
LXI	8305
Magnavox	8157
Marantz	8029, 8157
Matsui	8157
MCS	8029
Memorex	8032, 8305
Meridian	8157
Micromega	8157
Mission	8157
NAD	8000
Naim	8157
NSM	8157
Onkyo	8101
Optimus	8000, 8032, 8037, 8179, 8305, 8468
Panasonic	8029, 8303
Philips	8157
Pioneer	8032, 8305, 8468
Proton	8157

Maker	Set up codes
QED	8157
Quad	8157
Quasar	8029
RCA	8053, 8179, 8305
Realistic	8179
Revox	8157
Rotel	8157
SAE	8157
Sansui	8157, 8305
Sanyo	8179
Scott	8305
Sears	8305
Sharp	8037
Sony	8000, 8185, 8604, 8605
Soundesign	8145
Tandy	8032
Teac	8393
Technics	8029, 8303
Universum	8157
Victor	8072
Yamaha	8036, 8187

5 6 DAT deck Set up codes

Maker	Set up codes
Carver	7158
Denon	7031
Grundig	7158

Maker	Set up codes
Marantz	7158
Philips	7158

Maker	Set up codes
Sony	7093
Technics	7158

Cassette deck Set up codes

Maker	Set up codes
Aiwa	7029, 7197
Arcam	7076
Carver	7029
Denon	7076
Fisher	7074
Garrard	7308, 7309
Grundig	7029
Inkel	7071

Maker	Set up codes
JVC	7244, 7273, 7274
Kenwood	7000, 7071, 7183
Magnavox	7029
Marantz	7009, 7029
Onkyo	7136
Optimus	7027, 7220
Panasonic	7229
Philips	7029
Pioneer	7027, 7220

Maker	Set up codes
Revox	7029
Sansui	7009, 7029
Sony	7170, 7243, 7291
Teac	7308, 7309
Technics	7229
Victor	7244, 7273, 7274
Wards	7027
Yamaha	7094, 7097

MD Set up codes

Maker	Set up codes
Kenwood	9000, 9826
Sony	9490

Misc. audio Set up codes

Maker	Set up codes
Jerrold	8459, 8520

Maker	Set up codes
Scientific Atlanta	8460

Maker	Set up codes
Starcom	8459

Resetting the Microcomputer

If the microcomputer may malfunction (unit cannot be operated, or shows an erroneous display) if the power cord is unplugged while the power is ON, or due to some other external factor. If this happens, execute the following procedure to reset the microcomputer and return the unit to its normal operating condition.

With the power cord plugged in, turn the POWER key OFF. Then, while holding down the ON/STANDBY key, press POWER.

- Please note that resetting the microcomputer will clear the contents of the memory and returns the unit to the state it was in when it left the factory.

Amplifier

Symptom	Cause	Remedy
No sound from the speakers.	<ul style="list-style-type: none"> • The speaker cords are disconnected. • VOLUME is set to the minimum position. • MUTE is ON. • The SPEAKERS switches are set to OFF. 	<ul style="list-style-type: none"> • Connect them properly referring to "Connecting the speakers" → 13 • Adjust the volume to a proper level. • Turn OFF the MUTE. → 21 • Set the SPEAKERS switch(es) to ON. → 20
The standby indicator blinks and sound is not output.	<ul style="list-style-type: none"> • Speaker cords are short-circuited. 	<ul style="list-style-type: none"> • Turn the power off, eliminate the short-circuiting, then turn on the power again. → 13
Sound is not output from one of the speakers.	<ul style="list-style-type: none"> • The speaker cord is disconnected. • The speaker balance is set to an extreme position. 	<ul style="list-style-type: none"> • Connect it properly referring to "Connecting the speakers". • Adjust the speaker levels using the test tone. → 19
Sound is not output from the rear (surround) speakers and/or the center speaker, or their sound is very small.	<ul style="list-style-type: none"> • The rear speaker cords and/or the center speaker cord is disconnected. • A surround mode has not been engaged. • The rear and/or center volume controls are set to the minimum level. 	<ul style="list-style-type: none"> • Connect it properly referring to "Connecting the speakers". • Select a surround mode. • Adjust the speaker levels using the test tone. → 19
A humming noise is generated when the PHONO input selector is selected.	<ul style="list-style-type: none"> • The audio cord from the turntable is not connected to the PHONO jacks. • The turntable is not grounded. 	<ul style="list-style-type: none"> • Insert the audio cord plugs securely into the PHONO jacks. • Connect the grounding wire to the GND terminal on the rear panel.
The initial sound is intermittent when starting playback from an AC-3 source in a DVD player.	<ul style="list-style-type: none"> • There are different causes for different types of DVD players. 	<ul style="list-style-type: none"> • With certain DVD players, the initial sound may be intermittent.
No sound when playing a DVD.	<ul style="list-style-type: none"> • A PCM source is being played back. 	<ul style="list-style-type: none"> • Press the STEREO key.
Digital playback is not possible from Dolby Digital (AC-3) sources.	<ul style="list-style-type: none"> • The sound mode is set to "STEREO". 	<ul style="list-style-type: none"> • Press the DOLBY DIGITAL key to select the Dolby Digital (AC-3) mode.

Tuner

Symptom	Cause	Remedy
Radio Stations cannot be received.	<ul style="list-style-type: none"> • No antenna is connected. • The broadcast band is not set properly. • The frequency of the desired station is not tuned. 	<ul style="list-style-type: none"> • Connect an antenna. • Set the broadcast band properly. • Tune the frequency of the desired station. ∞
Interference.	<ul style="list-style-type: none"> • Noise due to ignition noise from an automobile. • Noise due to interference from an electric appliance. • Noise due to a nearby TV set. 	<ul style="list-style-type: none"> • Install the outdoor antenna away from the road. • Turn off the power to the appliance. • Install the receiver farther away from the TV.
A station which was preset cannot be received by pressing the corresponding numeric key.	<ul style="list-style-type: none"> • The preset station belongs to a frequency that cannot be received. • The preset memory was cleared because the power cord had been unplugged for a long period of time. 	<ul style="list-style-type: none"> • Preset a station with a receivable frequency. • Preset the station again.

Remote control unit

Symptom	Cause	Remedy
The backlight flashes five times during normal operation.	<ul style="list-style-type: none"> The batteries are nearing exhaustion. 	<ul style="list-style-type: none"> Replace with new batteries to preserve the currently registered setup information. → 16
Subwoofer volume cannot be adjusted.	<ul style="list-style-type: none"> Subwoofer is OFF. 	<ul style="list-style-type: none"> Turn the subwoofer ON. → 18
Certain inputs cannot be selected using the remote control.	<ul style="list-style-type: none"> No preset codes registered at for the respective input(s). 	<ul style="list-style-type: none"> Register a preset code or Non-IR code at the respective input(s). → 39
Remote control operation is not possible.	<ul style="list-style-type: none"> The remote control is set to a different operation mode. Batteries are exhausted. The remote control unit is too far away from the main system, controlling angle is too large, or there is an obstacle between the receiver and the remote. The audio cords and system control cords are not connected properly. No software is loaded in the source component. An attempt is made to play a tape which is being recorded in the cassette deck. The remote control has not been set to the operation mode for the component you wish to control. The remote control is in the Room B (A) operation mode. The microprocessor of the remote control malfunctions. 	<ul style="list-style-type: none"> Press VIDEO, AUDIO, or TV to select the appropriate operation mode. Replace with new batteries. If the backup is exhausted before you can replace the batteries, redo the setup procedure. → 16 → 40 Operate the remote control unit within the controllable range. Connect properly referring to "Setting up the system". → 8 Place software in the source component you want to play. Wait until recording has completed. Press the VIDEO, AUDIO, or TV key to activate the operation mode for the component you want to control before operation. → 43 Change the operation mode. → 47 Reset the microprocessor. → 48



Do not use contact cleaning agents because they could cause a malfunction. Be specifically careful against using contact cleaning agents containing oil, since they may deform the plastic components.

Memory back up function

Please note that the following items will be deleted from the unit's memory if the power cord is disconnected from the AC outlet or the main power switch is turned off for approximately 3 days.

- Power mode.
- Settings made using OSD (like SURROUND SET UP).
- Input selector settings.
- Volume level.
- Broadcast band.
- Frequency setting.
- Preset stations.

AUDIO section

Rated power output during STEREO operation	
(DIN) 1 kHz, 0.7% at 4 Ω	150 W + 150 W
(IEC) 63 Hz ~ 12.5 kHz, 0.7% at 4 Ω	150 W + 150 W
Rated power output during SURROUND operation	
FRONT(1kHz, 0.7% T.H.D. at 4 Ω)	150 W + 150 W
CENTER (1kHz, 0.7% T.H.D. at 4 Ω)	150 W
SURROUND(1kHz, 0.7% T.H.D. at 4 Ω)	150 W + 150 W
Total harmonic distortion	0.005 % (1kHz, 75 W, 4 Ω)
Frequency response	
CD	5 Hz ~ 85 kHz, +0.5 dB, -3 dB
Signal to noise ratio (DIN)	
PHONO (MM)	62 dB
CD	60 dB
Input sensitivity / impedance	
PHONO (MM)	2.5 mV / 47 kΩ
CD	200 mV / 47 kΩ
Output level / impedance	
TAPE REC	200 mV / 470 Ω
PRE OUT (FRONT, CENTER, SURROUND, SUBWOOFER)	1 V / 1.2 kΩ
Tone control	
BASS	±10 dB (at 100 Hz)
TREBLE	±10 dB (at 10 kHz)
LOUDNESS control	
VOLUME at -40dB level	+7 dB(100 Hz), +3 dB(10 kHz)

DIGITAL AUDIO section

Sampling frequency	32 kHz, 44.1 kHz, 48 kHz
Input level / impedance / wave length	
Optical	-15 dBm ~ -21 dBm, 600 nm ±30nm
Coaxial	0.5 Vp-p / 75 Ω

VIDEO section

Video format	PAL/NTSC auto switching
VIDEO inputs / outputs	
VIDEO (composite)	1 Vp-p / 75 Ω
S-VIDEO (luminance signal)	1 Vp-p / 75 Ω
(chrominance signal)	0.286 Vp-p / 75 Ω

FM tuner section

Tuning frequency range	87.5 MHz ~ 108 MHz
Usable sensitivity (DIN, 75 Ω)	
MONO	1.2 μV / 13.2 dBf (40 kHz DEV., S/N 26 dB)
STEREO	35 μV / 42.1 dBf (46 kHz DEV., S/N 46 dB)
Total harmonic distortion (DIN, 1 kHz)	
MONO	0.2 % (65.2 dBf input)
STEREO	0.5 % (65.2 dBf input)
Signal to noise ratio (DIN weighted, 1 kHz)	
MONO	65 dB (40 kHz DEV., 65.2 dBf input)
STEREO	60 dB (46 kHz DEV., 65.2 dBf input)
Stereo separation (DIN, 1 kHz)	40 dB
Selectivity (DIN, ±300 kHz)	64 dB
Frequency response (30 Hz ~ 15kHz)	+0.5 dB, -3.0 dB

AM tuner section

Tuning frequency range	531 kHz ~ 1,602 kHz
Usable sensitivity (30% mod., S/N 20 dB)	16 μV / (600 μV/m)
Signal to noise ratio (30 % mod., 1 mV input)	48 dB

GENERAL

Power consumption	420 W
AC outlet	
SWITCHED	2 (total 90 W max.)
Dimensions	W : 440 mm
	H : 162 mm
	D : 392 mm
Weight (Net)	13 kg

RF Demodulator (DEM-999D)

Input level	
AC-3 RF	50 mV p-p ~ 200 mV p-p
RF Frequency response	2.88 MHz ~ ±144 kHz
Output level / Impedance	
Coaxial	0.5 Vp-p / 75 Ω
Dimensions	W : 89 mm
	H : 35 mm
	D : 101 mm
Weight (Net)	200 g



KENWOOD follows a policy of continuous advancements in development. For this reason specifications may be changed without notice.

Remote operation of other components

Refer to the following for the type of remote control operations available for each component. The setup code for each component must be entered beforehand.

- 1 Use the **AUDIO**, **VIDEO**, or **TV** keys to select the component you want to control.
- 2 Press the keys corresponding to the operations you desire. Refer to the following sections for details.

- When pressing keys in succession, press each key firmly and be sure to wait at least 1 second before pressing the next key.
- Numeric keys function the same as the numeric keys on the original remote.
- To execute a **FUNCTION SHIFT** command, press the **FUNCTION SHIFT** key, then press the corresponding key within 3 seconds.



1. Although each setup code is designed to work with a number of different models, certain codes may not work with some models. (Also, certain codes may only operate some of the functions available on a given model.)
2. The charts below show the typical functions available for each component. Some manufacturers use different key combinations to perform similar functions. For that reason, we have programmed extra functions on some of the unused number keys to help you control your equipment. To find if your component has extra functions, press the **FUNCTION SHIFT** key, then press a number key. Repeat this procedure for each number key.

Tuner operations

TUNING/SKIP

TUNING ∞

▶/|| (BAND ∞)

■ (AUTO ∞)

◀◀ (P.CALL - → 29)

▶▶ (P.CALL + → 29)

ROOM B mode: P.CALL +/- only

FUNCTION SHIFT

MENU	THEME	FAV
1	2	3
TV/SAT/VID	INFO	ALT.AUD
4	5	6
+100	REPEAT	RANDOM
7	8	9
ROOM A	DISPLAY	ROOM B
+10	0	ENT

FUNCTION SHIFT commands

DISPLAY (Dimmer → 37)

Cassette deck operations

TUNING/SKIP

+ (▶ Play)

- (◀ Play)

REC

● (Record)

▶/|| (▶ Play)

|| (Pause)

■ (Stop)

◀◀ (◀◀ Rewind)

▶▶ (▶▶ Fast forward)

CD player operations

TUNING/SKIP

+ (Disc Skip +)

- (Disc Skip -)

▶/|| (Play/Pause {for SL16})

▶/|| (▶ Play {for other})

|| (Pause {for other})

■ (Stop)

◀◀ (Skip)

▶▶ (Skip)

FUNCTION SHIFT

MENU	THEME	FAV
1	2	3
TV/SAT/VID	INFO	ALT.AUD
4	5	6
+100	REPEAT	RANDOM
7	8	9
ROOM A	DISPLAY	ROOM B
+10	0	ENT

FUNCTION SHIFT commands

REPEAT (Repeat)

RANDOM (Random)

DISPLAY (Dimmer)

MD recorder operations

TUNING/SKIP

+ (▶▶ Search)

- (◀◀ Search)

▶/|| (▶ Play)

|| (Pause)

■ (Stop)

◀◀ (Skip back)

▶▶ (Skip forward)

FUNCTION SHIFT

MENU	THEME	FAV
1	2	3
TV/SAT/VID	INFO	ALT.AUD
4	5	6
+100	REPEAT	RANDOM
7	8	9
ROOM A	DISPLAY	ROOM B
+10	0	ENT

FUNCTION SHIFT commands

+100 (+100)

REPEAT (Repeat)

RANDOM (Random)

DISPLAY (Dimmer)

TV operations

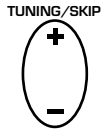

+ (Channel +)
- (Channel -)

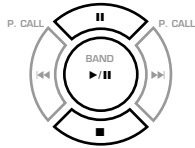

▶/|| (Mute)
|| (Volume +)
■ (Volume -)

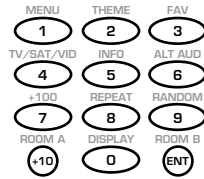

Numeric keys

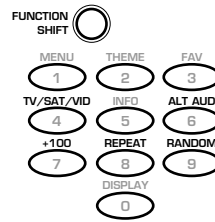

FUNCTION SHIFT commands
TV/SAT./VID (Input selector)
ALT AUDIO (Alternate audio)
+100 (TV TEXT)
REPEAT (Text off)
RANDOM (MIX)

VCR operations

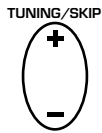

+ (Channel +)
- (Channel -)

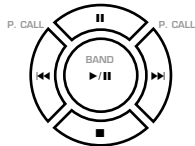

▶/|| (▶ Play)
|| (Pause)
■ (Stop)
◀◀ (◀◀ Rewind)
▶▶ (▶▶ Fast forward)

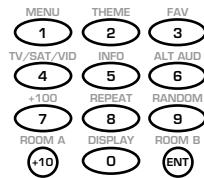

Numeric keys

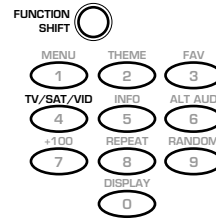

FUNCTION SHIFT commands
TV/SAT./VID (Input selector)

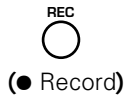

LD player operations

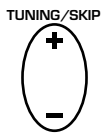

+ (A, A/B)
- (B)

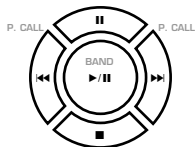

▶/|| (▶ Play)
|| (Pause)
■ (Stop)
◀◀ (Skip back)
▶▶ (Skip forward)

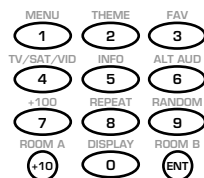

Numeric keys

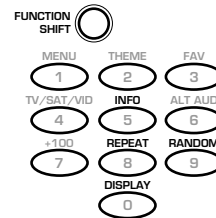

FUNCTION SHIFT commands
INFO (Frame-time)
REPEAT (Repeat)
RANDOM (Random)
DISPLAY (Display)



Satellite tuner operations

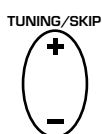

+ (Channel +)
- (Channel -)

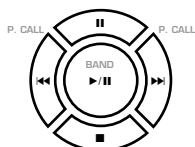

▶/|| (Select)
|| (↑)
■ (↓)
◀◀ (←)
▶▶ (→)

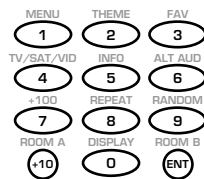

Numeric keys

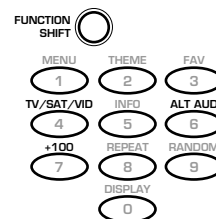

FUNCTION SHIFT commands
TV/SAT./VID (Input selector)
ALT AUDIO (Alternate audio)
+100 (+100)



Cable tuner operations

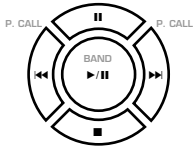
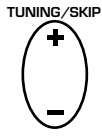

- + (Channel +)
- (Channel -)
- ▶/|| (Select)
- || (↑)
- (↓)
- ◀◀ (←)
- ▶▶ (→)

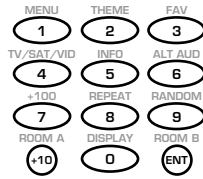

Numeric keys

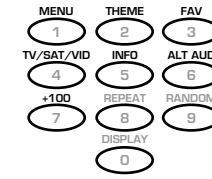

FUNCTION SHIFT commands

- MENU (Menu)
- THEME (Theme)
- FAV. (Favorite)
- TV/SAT./VID (Input selector)
- INFO (Page)
- ALT AUDIO (Alternate audio)
- +100 (+100)



DVD player operations

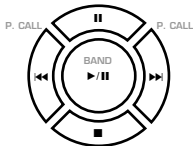
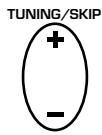

- + (Disc skip +)
- (Disc skip -)
- ▶/|| (▶ Play)
- || (Pause)
- (Stop)
- ◀◀ (Skip back)
- ▶▶ (Skip forward)

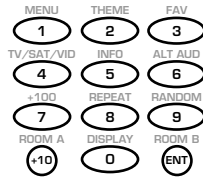

Numeric keys

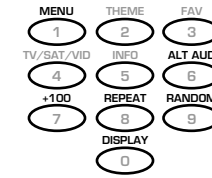
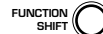

FUNCTION SHIFT commands

- ALT AUDIO (Alternate audio)
- +100 (+100)
- REPEAT (Repeat)
- RANDOM (Random)
- DISPLAY (Display)





KENWOOD

For your records

Record the serial number, found on the back of the unit, in the spaces designated on the warranty card, and in the space provided below. Refer to the model and serial numbers whenever you call upon your dealer for information or service on this product.

Model _____ Serial Number _____

For the United Kingdom

Factory fitted moulded mains plug

1. The mains plug contains a fuse. For replacement, use only a 13-Amp ASTA-approved (BS1362) fuse.
2. The fuse cover must be refitted when replacing the fuse in the moulded plug.
3. Do not cut off the mains plug from this equipment. If the plug fitted is not suitable for the power points in your home or the cable is too short to reach a power point, then obtain an appropriate safety approved extension lead or adapter, or consult your dealer.
If nonetheless the mains plug is cut off, remove the fuse and dispose of the plug immediately, to avoid a possible shock hazard by inadvertent connection to the mains supply.

IMPORTANT

The wires in the mains lead are coloured in accordance with the following code.

Blue : Neutral

Brown: Live

Do not connect those leads to the earth terminal of a three-pin plug.